



HAL
open science

Role of plant rhizosphere across multiple species, grassland management and temperature on microbial communities and long term soil organic matter dynamics

Tanvir Shahzad

► To cite this version:

Tanvir Shahzad. Role of plant rhizosphere across multiple species, grassland management and temperature on microbial communities and long term soil organic matter dynamics. Agricultural sciences. AgroParisTech, 2012. English. NNT : 2012AGPT0032 . pastel-00772440

HAL Id: pastel-00772440

<https://pastel.hal.science/pastel-00772440>

Submitted on 10 Jan 2013

HAL is a multi-disciplinary open access archive for the deposit and dissemination of scientific research documents, whether they are published or not. The documents may come from teaching and research institutions in France or abroad, or from public or private research centers.

L'archive ouverte pluridisciplinaire **HAL**, est destinée au dépôt et à la diffusion de documents scientifiques de niveau recherche, publiés ou non, émanant des établissements d'enseignement et de recherche français ou étrangers, des laboratoires publics ou privés.



Doctorat ParisTech

THÈSE

pour obtenir le grade de docteur délivré par

**L'Institut des Sciences et Industries
du Vivant et de l'Environnement**

(AgroParisTech)

Spécialités : Ecologie, Biogéochimie, Agronomie

Présentée et soutenue publiquement par

Tanvir SHAHZAD

le 30 Mars 2012

**Role of plant rhizosphere across multiple species, grassland
management and temperature on microbial communities
and long term soil organic matter dynamics**

Directeurs de thèse

Claire CHENU et Sébastien FONTAINE

Jury

Mme. Evgenia Blagodatskaya

M. Sébastien BAROT

Mme. Sylvie Recous

M. Pierre Barré

Mme. Claire CHENU

M. Sébastien FONTAINE

Pr. Georg-August-Universität Göttingen Germany

DR. UMR 7618 Bioemco IRD, CNRS, UPMC, ENS Paris

DR, UMR614 INRA-URCA Reims

CR. Laboratoire de Géologie, UMR8538 ENS CNRS, Paris

Pr. AgroParisTech UMR Bioemco Thiverval Grignon

CR. INRA UR Ecosystème Prairial Clermont Ferrand

Rapporteur

Rapporteur

Présidente

Examinateur

Directrice de thèse

Directeur de thèse

INSTITUT NATIONAL DE LA RECHERCHE AGRONOMIQUE

Unité de Recherche sur l'Ecosystème Prairial

234-Avenue du Brézet 63100, Clermont Ferrand, France

Dedicated to

Waniya

Amna

Ammi

ACKNOWLEDGEMENT

Foremost, I am heartily grateful to the jury members who accepted to dedicate their precious time to evaluate this work: Evgenia (Jane) Blagodatskaya, Sébastien Barot, Sylvie Recous, Pierre Barré, Claire Chenu and Sébastien Fontaine.

My sincere thanks go to Jean-François Soussana who welcomed me in INRA-*Unité de Recherche sur l'Ecosystème Prairial* and also to Pascal Carrère who helped me through various administrative issues during this long project.

I am indebted to Higher Education Commission of Pakistan for providing me the financial assistance in the first place to come and realize the PhD in France.

My sincere and cordial gratitude to my PhD advisor Sébastien Fontaine for his continuous support, trust, patience, rich and mostly scientific and some times unscientific discussions, passion of research that he wittingly or unwittingly imparted to me and quiet and loud encouragement. He strives for originality in research and I thank him for making me to believe the value of this trait. Over the years, I was impressed by his capacity of combining the critique with immediate empathy and commitment to his co-workers, especially students.

I am equally thankful to Claire Chenu, also my PhD advisor, who, despite some geographical distance was always there to help me whenever I needed. Her contribution in formulating the scientific questions was very constructive. Her productive comments on the earlier drafts of main chapters contributed a lot to their objectivity and clarity.

This work would not have seen accomplishment without the regular and rigorous isotopic analyses carried out by Olivier Delfosse from INRA-Reims. I am highly indebted to his cooperation during this work. Thanks to Robert Falcimagne for making the labelling system function, Maurice Crocombette and Patrick Pichon for constructing and putting in place the mesocosm. I am grateful to Jean-Luc Ollier for analyses on inorganic C. Thanks also to Laurence (VetAgroSup, Clermont Ferrand) for mineral N analyses. Thanks to Cédric and Rachid for providing me opportunity of PLFA analyses.

A big thanks to all at INRA-UREP who transform the workplace into a convivial setting: Vincent with whom I shared had a lot of discussions on science and geopolitics, Raphaël a witty being against whom I played some high class tennis, Sandrine my office mate an Auvergnate who helped me in my experiments and who tried her hard but in vain over the years to make me learn some Auvergnat expressions, Anne-Isabelle, Juliette, Rémi, Katja,

Hythem, Romain, Frank, Marine, Antoine, Alex, Mathilde, Olivier, Lionel, Mickael and lastly Gaël whose intellectual inquisitiveness is just admirable. Thank you *les amis!*

Memories of my stay at Clermont Ferrand will remain a treasure for my life. Thanks to Umar, Ayesha, Gills, Suha, Sameer, Muneeb, Mudassir, and Nazia who turned the time into nonchalant and pleasant ride.

Thanks to my brothers Aamir and Abrar and my sisters Samina and Nabeela for their love and moral support.

I would not be able to thank enough Amna, for the love and care she gives me. Love to my little daughter, Waniya, whose joyfulness used to lessen the fatigue of the write up.

My sincere gratitude to Abbu and Ammi whose encouragement and prayers kept me going through this adventure.

Tanvir Shahzad

Sommaire

CHAPTER 1	3
GENERAL INTRODUCTION	3
I. CONTEXT OF STUDY	3
I.1. GLOBAL CARBON CYCLE	3
I.2. SOIL ORGANIC CARBON	3
I.3. INTERACTION OF C CYCLE WITH OTHER CYCLES	3
II. STATE OF THE ART	3
II.1. INTRODUCTION TO PRIMING EFFECT	3
II.2. MEASURING PRIMING EFFECT	3
II.3. WHY PRIMING EFFECT IS IMPORTANT	3
II.4. KNOWLEDGE GAPS	3
III. OBJECTIVES OF THESIS	3
III.1. HYPOTHESES OF THESIS	3
III.2. APPROACHES OF THE STUDY	3
IV. THESIS LAYOUT	3
V. REFERENCES	3
CHAPTER 2	3
PLANT CLIPPING DECELERATES THE MINERALIZATION OF RECALCITRANT SOIL ORGANIC MATTER UNDER MULTIPLE GRASSLAND SPECIES	3
I. SUMMARY	3
II. INTRODUCTION	3
III. MATERIALS & METHODS:	3
III.1. SOIL SAMPLING AND PLANT SOWING	3
III.2. LABELLING SYSTEM & MESOCOSM	3
III.3. RESPIRATION MEASUREMENT	3
III.4. SOIL AND PLANT ANALYSES	3
III.5. PLFA MEASUREMENTS	3

III.6. STATISTICAL ANALYSES	3
IV. RESULTS	3
IV.1. PLANT BIOMASS AND ISOTOPIC COMPOSITION	3
IV.2. RESPIRATION FLUXES	3
IV.3. SOLUBLE C & MINERAL NITROGEN IN SOIL.....	3
IV.4. MICROBIAL BIOMASS & COMMUNITY COMPOSITION.....	3
V. DISCUSSION.....	3
VI. REFERENCES.....	3
CHAPTER 3	3
LIVING ROOTS INDUCE THE MINERALIZATION OF 15, 000 YEARS OLD ORGANIC C FROM DEEP SOIL OF A TEMPERATE GRASSLAND.....	3
I. SUMMARY	3
II. INTRODUCTION.....	3
III. MATERIALS & METHODS	3
III.1. SOIL SAMPLING AND PLANT SOWING.....	3
III.2. RESPIRATION MEASURES	3
III.3. SOIL CARBON FRACTIONS	3
III.4. SOIL NITROGEN.....	3
III.5. PLFA MEASUREMENTS.....	3
III.6. STATISTICAL ANALYSES	3
IV. RESULTS	3
IV.1. SOM MINERALIZATION & RHIZOSPHERE PRIMING EFFECT.....	3
IV.2. MINERAL NITROGEN IN SOIL.....	3
IV.3. ROOT LITTER AND SOIL ORGANIC C.....	3
IV.4. MICROBIAL BIOMASS & COMMUNITY COMPOSITION.....	3
V. DISCUSSION.....	3
VI. CONCLUSION	3
VII. REFERENCES	3
CHAPTER 4	3

TEMPERATURE RESPONSE OF ORGANIC C MINERALIZATION: A NEW EXPERIMENTALLY TESTED THEORY BASED ON ENZYME INACTIVATION AND MICROBIAL ENERGY LIMITATION RECONCILES THE RESULTS OF LAB AND ECOSYSTEM EXPERIMENTS.....	3
I. SUMMARY	3
II. INTRODUCTION.....	3
III. THEORY	3
IV. EXPERIMENTAL TEST.....	3
V. MATERIALS AND METHODS.....	3
V.1. SOIL SAMPLING AND EXPERIMENTAL DESIGN.....	3
V.2. LABELLING SYSTEM & MESOCOSM	3
V.3. RESPIRATION MEASUREMENT	3
V.4. STATISTICAL ANALYSIS	3
VI. RESULTS	3
VI.1. EFFECT OF PLANT ON SOIL RESPIRATION.....	3
VI.2. EFFECT OF TEMPERATURE ON FRESH C RESPIRATION	3
VI.3. TESTING THE THEORY: EFFECT OF TEMPERATURE ON RECALCITRANT C MINERALIZATION IN PLANTED AND BARE SOILS	3
VII. CONCLUSION.....	3
VIII. REFERENCES	3
CHAPTER 5	3
ARTICLES IN PREPARATION.....	3
PART 1: THE EFFECT OF SIX GRAMINEAE AND ONE LEGUMINOUS SPECIES ON SOIL ORGANIC MATTER DYNAMICS IN TEMPERATE GRASSLAND.....	3
PART 2: DOES HIGHER AVAILABILITY OF N DECREASE SOIL ORGANIC C MINERALIZATION AND STORE MORE ORGANIC C?	3
PART 3: DECOUPLING THE EFFECT OF ROOT EXUDATES, MYCORRHIZAE AND ROOTS ON SOIL C PROCESSES IN THREE TEMPERATE GRASSLAND SPECIES	3

REFERENCES	3
CHAPTER 6	3
ROLE OF PLANT RHIZOSPHERE ACROSS MULTIPLE SPECIES, GRASSLAND MANAGEMENT AND TEMPERATURE ON MICROBIAL COMMUNITIES AND LONG-TERM SOIL ORGANIC MATTER DYNAMICS	3
I. GENERAL DISCUSSION	3
II. PERSPECTIVES.....	3
III. REFERENCES:	3
ANNEX OF THE THESIS	3
ACELLULAR RESPIRATION: RECONSTITUTION OF AN OXIDATIVE METABOLISM BY ENZYMES RELEASED FROM DEAD CELLS	3

Abstract

It is increasingly being recognized that the soil microbes can mineralize recalcitrant soil organic matter (SOM) by using the fresh carbon (C) as a source of energy, a process called priming effect (PE). It has been shown mostly in lab incubations that PE can have important consequences for sequestration of organic C in soils. However, the importance of PE in C and N dynamics of ecosystems remains little known. The soil-plant interactions and rhizospheric processes can modulate the rates of PE and its consequences on C and N dynamics in an ecosystem.

The objective of this thesis was to determine the role of PE in the C and N dynamics of permanent grasslands and the modulation of this role in response to management (plant clipping, fertilization) and global warming. Moreover, it was aimed to identify the microbial groups involved in PE and to unravel the way, e.g. absorption of N, root exudations and litter deposition, by which plant can induce PE.

The thesis was based on a new approach allowing continuous dual labelling of multiple grassland plants with ^{13}C - and ^{14}C - CO_2 . The dual labelling permitted the separation of soil-derived CO_2 from plant-derived CO_2 , the calculation of PE and the determination of mean age of soil-derived CO_2 -C. Moreover, phospholipids fatty-acids analysis (PLFA) permitted to correlate the variation of PE with changes in microbial community composition.

Our work showed that the increased SOM mineralization under grasses was consistently two to three times more than that in bare soils (i.e. PE) over long term (511 days). This reveals that the PE plays key role in ecosystem CO_2 -C flux and indicates that a very large pool of SOM is under the control of PE. Moreover, we report that 15,000 years old organic C from an undisturbed deep soil can be mineralized after the supply of fresh C by living plants to soil microbes. This result supports the idea that the SOM in deep soils is stable due to the energy-limitation of microbes and the 'inert' pool of organic C defined in current models is not so 'inert' finally.

The supply of N in soil-plant system through the use of fertilizer or legume decreased the PE suggesting that the C storage in soils is limited by nutrient supply. Similarly, plant clipping reduced the plant N uptake thereby PE. Collectively these results suggest synchronization between plant N uptake and SOM mineralization supporting the idea that soils under permanent plant cover function as a bank of nutrients for the plant, maximizing plant productivity and nutrient retention.

An innovative method clearly showed that the root exudation is the major way by which grassland plants induce PE. Moreover, saprophytic fungi are suggested as the key actors in the mineralization of recalcitrant SOM & PE.

Lastly, we developed a new theory on temperature response of SOM mineralization by taking into account the energy-limitation of microbes and the temperature-dependent inactivation of enzymes. This theory predicts a negative relationship between temperature and mineralization of recalcitrant SOM, which was supported by experimental results. This finding challenges the classical paradigm of positive relationship between temperature and recalcitrant SOM mineralization.

Overall, these investigations on plant-soil systems reinforce the idea that PE and underlying mechanisms play a key role in ecosystem C and N dynamics and even suggest that this role was underestimated in lab experiments.

CHAPTER 1

General Introduction

GENERAL INTRODUCTION

I. Context of study

I.1. Global carbon cycle

The carbon (C) cycle, like every biogeochemical cycle, is a complex cycle consisting of different pools and stocks (Figure 1.1). For better understanding, this cycle can be divided into two components, mineral (CO_2 , CH_4 , CaCO_3 etc.) and organic. These two components are connected together *via* different fluxes like plant photosynthesis and soil respiration. The strong link between global C cycle and world climate is the reason why global C cycle gets such important attention from world's scientific community.

Since the industrial era commenced (around 1750), huge changes in global C stocks and fluxes between them have occurred (IPCC, Figure 1.1, In red are quantities due to anthropogenic changes post 1750 and in black are pre-1750 estimations). Prior to 1750, the atmospheric concentration of CO_2 , the most important greenhouse gas, had been relatively stable between 260 and 280 ppm for 10 kyr (Petit et al., 1999; Siegenthaler et al., 2005). Perturbations of the carbon cycle from human activities were insignificant relative to natural variability. Since 1750, the concentration of CO_2 in the atmosphere has risen, at an increasing rate, from around 280 ppm to nearly 380 ppm in 2005. The increase in atmospheric CO_2 concentration results from human activities: primarily burning of fossil fuels and deforestation, but also cement production and changes in land use and management such as biomass burning, crop production and conversion of grasslands to croplands. While human activities contribute to climate change in many direct and indirect ways, CO_2 emissions from human activities are considered the single largest anthropogenic factor contributing to climate change.

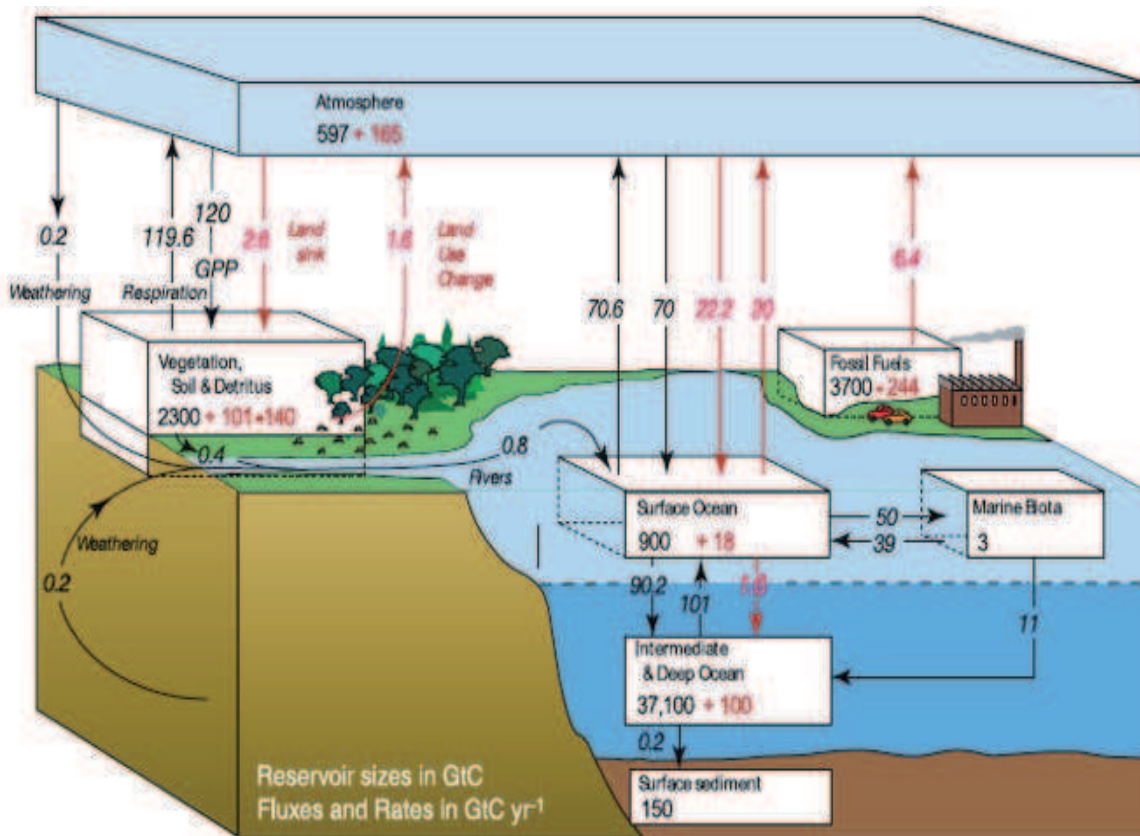

Figure 1.1. The global carbon cycle for the 1990s, showing the main annual fluxes in GtC yr⁻¹: pre-industrial 'natural' fluxes in black and 'anthropogenic' fluxes in red

Source: http://www.ipcc.ch/publications_and_data/ar4/wg1/en/ch7s7-3.html

The anthropogenic rise in CO₂ levels in the atmosphere contributes to greenhouse effect which increases global mean temperature of Earth's surface. This situation has stimulated the research on analysis of global C stocks as sources and sinks of CO₂ and the means to limit these anthropogenic effects. This concept of global C stocks as sources and sinks was upheld and popularized by Kyoto protocol 1997 that was held to minimize the emissions of green house gases. One of the most important C stocks on Earth is inorganic C dissolved in deep oceans that represents 38.30¹² t C (Millennium Ecosystem Assessment 2005). These stocks of passive C can not be manipulated since they are regulated by oceanic currents and the dissolution of the atmospheric CO₂ in the oceans over which human activity has little control. However the soil C stocks are manageable by human activities and have

been identified as important potential sinks in Kyoto protocol. Moreover, the important quantities of soil C stocks and respiration from them being the largest flux in global C cycle make these stocks of high stakes in the context of global climate change.

I.2. Soil organic carbon

The global mass of soil organic carbon (SOC) is at least ~ 2300 Pg C (Jobbàgy and Jackson 2000). It represents ~ 75% of the total land biosphere C reservoir given that the litter and vegetation C stocks amount to 850 Pg C (Houghton 2005). A small change in soil C stocks may cause important changes in global C cycle and potential feedbacks to climate change (Schlesinger and Andrews 2000) underpinning their potential role as important source or sink of CO₂.

The stocks of organic matter in soils are the result of balance between the inputs and outputs of C within the belowground environment. The inputs are products of net primary productivity like root exudates, plant litter, crop stubbles etc. The outputs are the release of C from soil principally as CO₂ although CH₄ efflux and hydrologic leaching of dissolved and particulate C compounds can also be important. The CO₂ release consists of microbial decomposition of soil organic matter. The size of inputs as well as outputs is determined by a variety of factors thus generating a range of soil organic C stocks around the world (For details, Figure 1.2).

The organic matter in soils is mainly stabilized by three mechanisms i.e. chemical stabilization, physical protection and biochemical stabilization (Stevenson 1994; Christensen 1996). Chemical stabilization of SOM is understood to be the result of chemical and or physicochemical binding between SOM and soil minerals like clay and silt particles (Sorensen 1972; Merckx et al., 1985; Chenu and Stotzky 2002). Physical protection is indicated by the positive influence of aggregates on the accumulation of SOM (Edwards and Bremer 1967; Elliot 1986; Jastrow 1996), particularly the micro-aggregates have been

proposed as the major sites of organic matter stabilization (Chenu and Plante 2006). The aggregates protect SOM from decomposition by entrapping and making it inaccessible to microbes. Biochemical stabilization of SOM occurs due to the

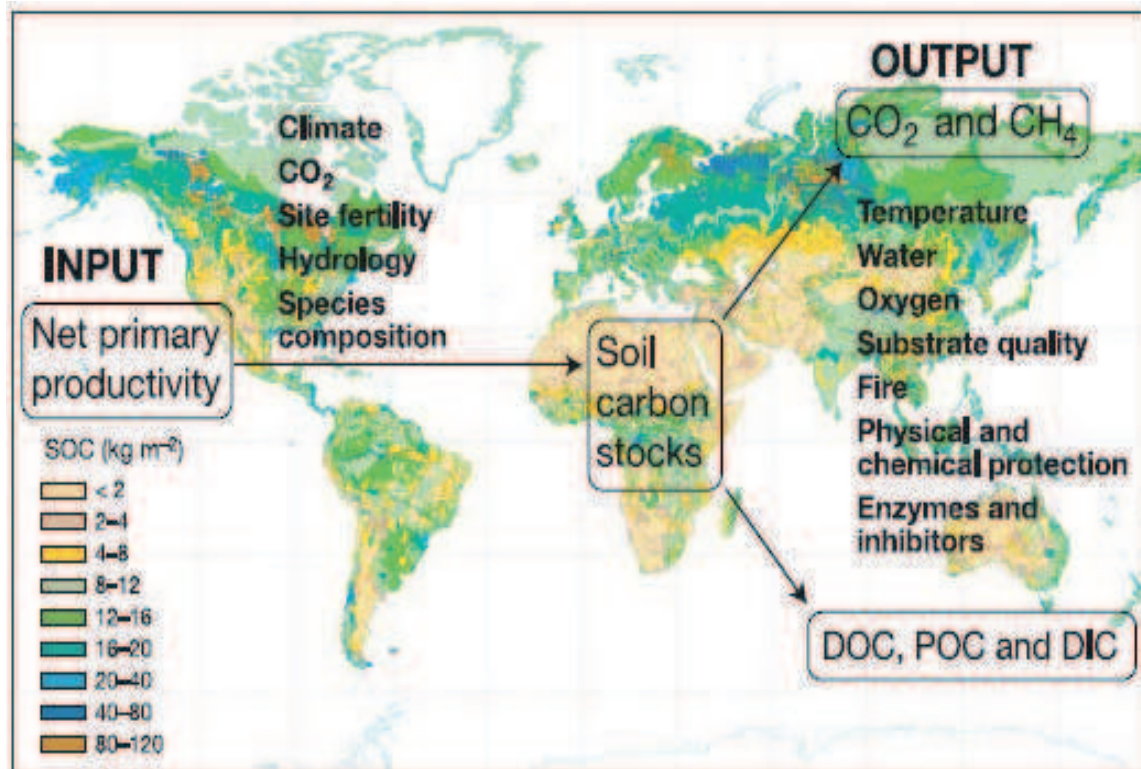

Figure 1.2. Factors controlling the main inputs and outputs of soil C, superimposed over a global map of soil organic C stocks (Miller projection; 1 : 100,000,000 for background map). Taken from Davidson & Janssens (2006).

complex chemical composition of the organic materials. The complex chemical composition can be an inherent property of the plant material (like lignin, polyphenols) or can be attained during decomposition through the condensation and complexation of decomposition residues, rendering them more resistant to subsequent decomposition. The microbes must invest energy to produce high concentrations of enzymes to break the high number of chemical bonds in such compounds. However, the metabolites acquired as a result of decomposition of such

compounds are not economically viable for microbes (Fontaine et al., 2007). That is why chemically complex organic compounds may remain stable.

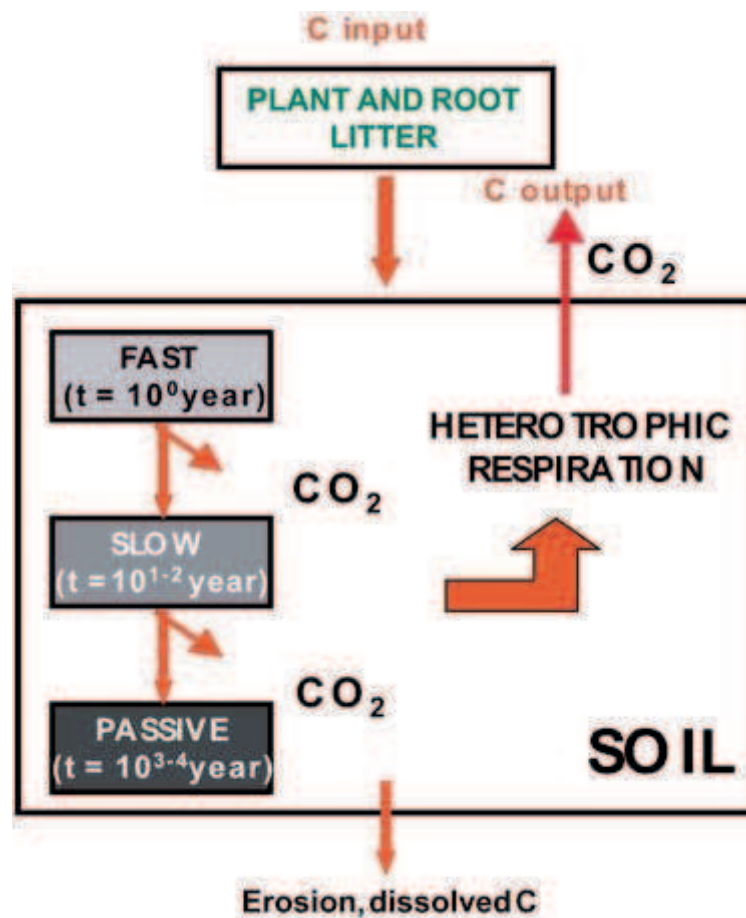

Figure 1.3. Simplified quality-wise fractions of soil organic C

Source: <http://www.fao.org/docrep/007/y5738e/y5738e05.htm>

Although SOM is a continuum of biochemical complexity, for the purpose of understanding it has been divided into three pools depending on their turnover rates (Figure 1.3, and Parton et al., 1987; Coleman et al., 1997; Wutzler and Reichstein 2008). The ‘fast’ pool turns over within hours to weeks, the ‘slow’ pool turns over within some years to decades and the ‘passive’ pool turns over in centuries to millennia (Lützow et al., 2006). A recent evidence has shown that the ‘passiveness’ of the ‘passive’ pool is due to energy-limitation faced by soil microbes (Fontaine et al., 2007). If microbes are provided with an energy-rich substrate they can co-metabolize the millennia old C from ‘passive’ pool.

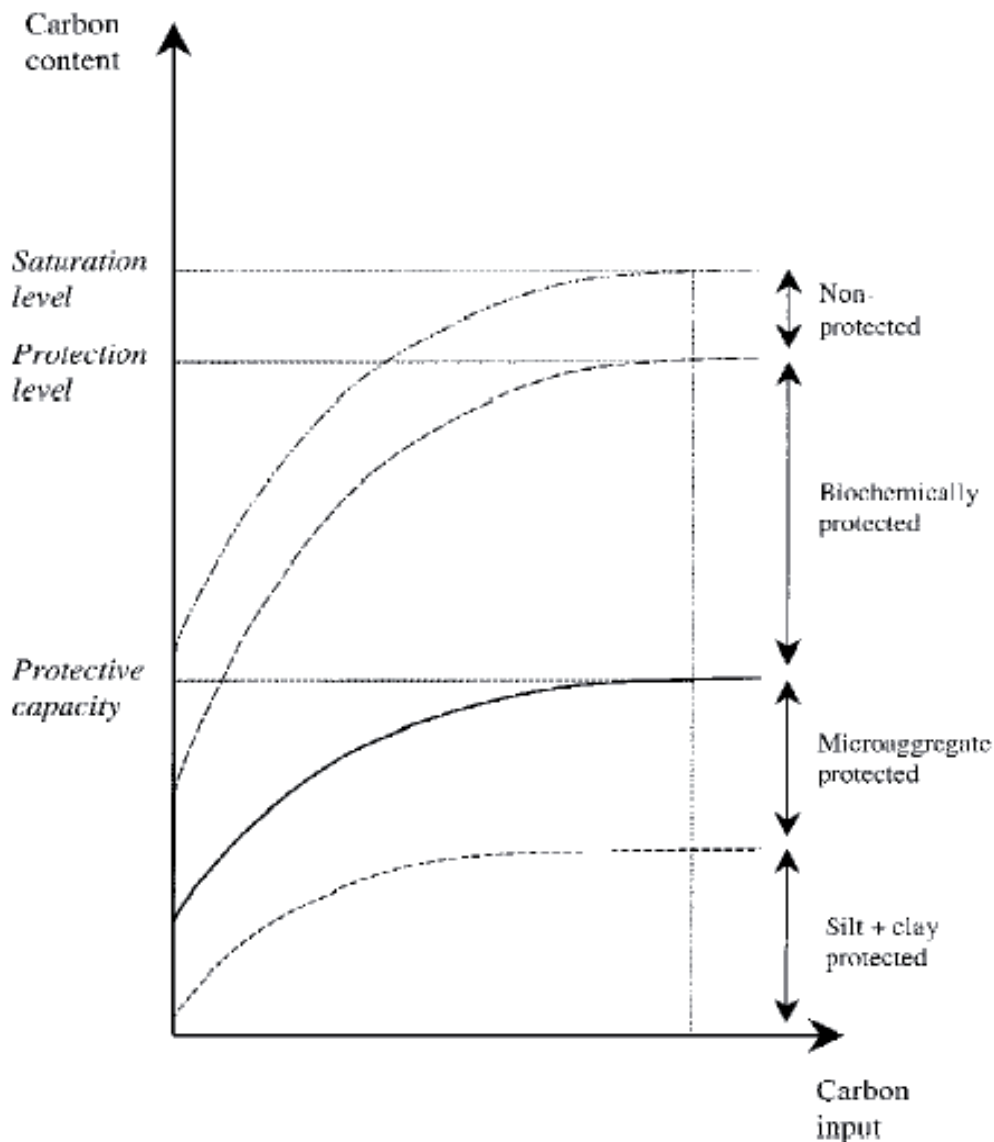

Figure 1.4. The protective capacity of soil (which governs the silt and clay and micro-aggregate protected C pools), the biochemically stabilized C pool and unprotected C pool define a maximum C content for soils. The pool size of each fraction is determined by their unique stabilizing mechanisms. (Six *et al.*, 2002)

The above described soil C stabilizing mechanisms determine soil C saturation limit in terms of a soil's capacity to act as sink for C (Figure 1.4, Six *et al.*, 2002). The important stocks of SOC as well as their long mean residence times (MRT) suggest soils as potentially important sink for minimizing the effect of anthropogenic emissions by fixing C in vegetation and its stabilization and humification in soils. This model also indicates that the capacity of

soils to raise their C stocks is limited (Six et al., 2002; Jastrow et al., 2005; Hungate et al., 2009). However, the chronosequence studies have shown that the soils have unlimited capacity of soil C sequestration (Syers et al., 1970; Schlesinger 1990).

The soil microbes performing the mineralization of SOM use C as energy as well as assimilate it along with other nutrients as their DNA. The stabilization and mineralization of SOM is thus not exclusively dependent on inputs and outputs of C but on the availability of other nutrients as well.

I.3. Interaction of C cycle with other cycles

Six major elements-H, C, N, O, S and P- constitute the major building blocks for all biological macromolecules (Schlesinger WH, 1997). As a result of constitutional needs of organisms for these elements to build their tissues, the elemental cycles of C, N and other elements are interlinked at the molecular level (Sternner RW & Elser JJ 2002). For example the anthropogenic additions of N in atmosphere are deposited back on ground in the forms that are readily available to plants thereby stimulating productivity and enhancing the uptake of CO₂ from the atmosphere. In contrast, the increase in plant biomass production under elevated CO₂ strongly depends on the availability of mineral N i.e. more the N is available; higher would be the production of plant biomass (Figure 1.5). Moreover, the stimulation of plant growth by elevated CO₂ should lead to sequestration of soil available nutrients and hence to progressive N limitation. The progressive N limitation hypothesis suggests that the increased plant biomass and plant fixation of CO₂ under elevated CO₂ subsides in the long term.

Similarly in soils, one of the reasons of difficulty to understand and theorize the dynamics of biogeochemical cycles is the inter-dependence of these cycles through soil organisms. The presence of P and N in important quantities in DNA, RNA, ATP and proteins underlines its key role in soil micro-organisms (Fagerbakke et al., 1996). Any increase in microbial biomass in soil due to additional availability of C for example under living roots, will strongly be

dependent on the availability of P. Soil organic matter, a major component of soil C (Batjes 1996), is another point of interlink for various biogeochemical cycles due to its chemistry. Soil organic matter (including fresh plant-derived C and soil humified recalcitrant C) is a major source of energy as well as various nutrients for soil microbes for cellular activity and growth. The understanding of dynamics of C cycle in soil without the knowledge about other biogeochemical cycles, like N and P, is hence difficult.

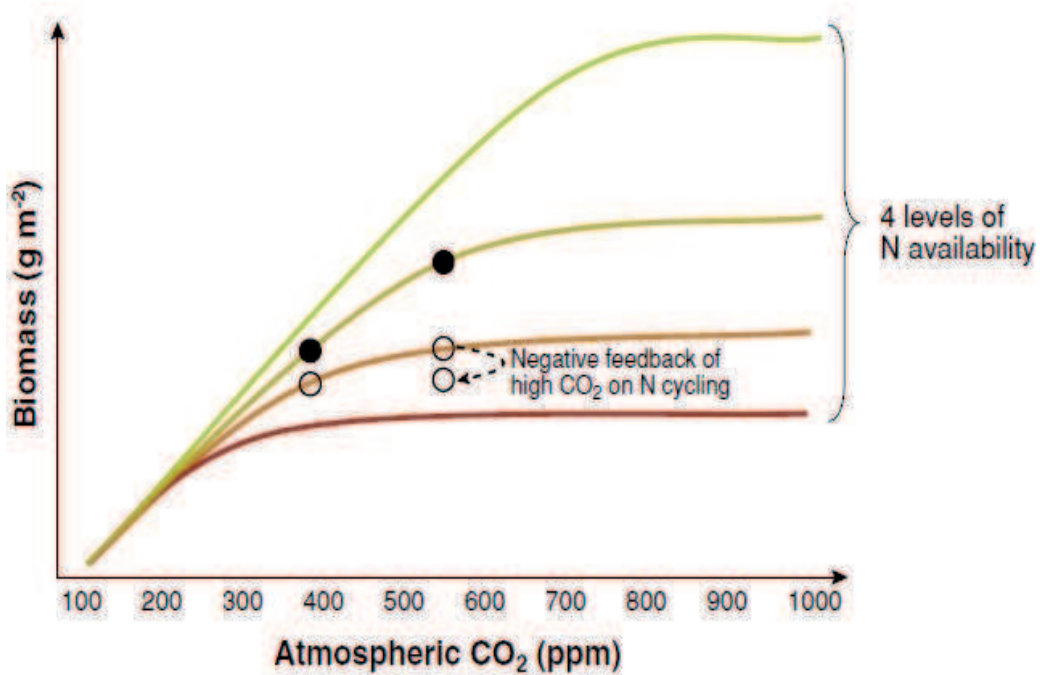

Figure 1.5. Theoretical demonstration of CO₂-N interactions. Biomass increase with a 50% increase in CO₂ concentration is greater at higher than lower N supply rates. Moreover elevated CO₂ can diminish N availability (Progressive N limitation), further stopping biomass increase at elevated CO₂ (taken from Reich et al., 2006)

The importance of availability of mineral N for storing C in soils has recently been observed at ecosystem level. It seems that, when mineral N availability is weak, the soil does not store excess C coming from increased plant production under elevated CO₂. Moreover, turnover of soil C stocks seems to be increased in this condition (Hungate et al., 2009). In

contrast, when mineral N is relatively high in availability, the total stock of C appears to go up due to reduced turnover of soil C stocks (van Groenigen et al., 2006; Hungate et al., 2009).

The fact that the amount of organic C stored in the soil does not necessarily increase, and can even decrease, after an input of fresh organic matter had been demonstrated in lab incubations (Fontaine et al, 2004a and b). These incubation experiments show that certain microbial species (Fontaine et al., 2003; Blagodatskaya et al., 2007) are able to degrade recalcitrant soil organic matter by using energy-rich substrates present in the fresh organic matter, a co-metabolism named priming effect in soil science (Blagodatskaya and Kuzyakov 2008). Although the mechanisms at play are not understood, the availability of nutrients for soil microbes controls the intensity of the priming effect. When the availability of nutrient is high, the priming effect is relatively low and the supply of fresh organic matter increase the reserve of C in soil. When the availability of nutrients is low, the priming effect may be so high that the reserve of C in soil decrease with the supply of fresh organic matter. Therefore, priming effect provides another good example of how C cycle in soil is interlinked with cycles of other nutrients.

II. State of the art

The acceleration in mineralization of recalcitrant SOM after the supply of fresh (labile) C i.e. priming effect is the cornerstone of this thesis. Thus it would be pertinent to understand in detail what this phenomenon is, its historical background, its precise definition in the context of this study, its importance for SOM mineralization and the methods to measure.

II.1. Introduction to priming effect

The extra release of soil-derived C as CO₂ or soil nitrogen as NH₄⁺ or as NO₃⁻ from soils amended with substrates in comparison to non-amended soils was termed as ‘priming effect’ (PE). Löhnis (1926) first suggested the PE by studying the N input-output balance of fields

amended with green manure of legumes. He showed that the N balance could only be explained by considering a significant acceleration of native soil organic matter mineralization induced by the green manure. No progress was made on the subject until 1946 when isotopic techniques source partitioning of CO₂ evolution from soil and Broadbent and Norman (1946) showed that the CO₂ evolution from the soil can increase from 4 to 11 fold after addition of ¹³C labelled plant residues. The term “*priming effect*” was however introduced by Bingemann et al. (1953). Since its introduction by Bingemann et al. in 1953, the term priming effect has also been used in other context and for describing other processes (Jenkinson et al., 1985; Dalenberg and Jager 1989). The focus of this thesis is SOM mineralization we refer to the original definition of priming effect given by by Bingeman et al. (1953), “the extra decomposition of native soil organic matter in a soil receiving an organic matter amendment” in this manuscript. Since priming effect in this work was studied in the presence of living roots (i.e. rhizosphere), it will be termed as rhizosphere priming effect (RPE).

What is the rationale behind this priming effect induced by soil microorganisms? According to energy limitation theory (Fontaine et al., 2005; 2007), despite the presence of large soil organic carbon stocks in most soils, the soil microbes are unable to use it for assimilation and growth because the direct and indirect (cell maintenance) cost on synthesizing extracellular enzymes that mineralize SOM exceeds the return the microbes could get in terms of energy and nutrients. However, some microbial species mineralize recalcitrant SOM in co-metabolism using the fresh organic matter as a source of energy (Fontaine et al., 2003; Blagodatskaya et al., 2007). This degradation of recalcitrant SOM would permit microorganisms to access to the large reserve of nutrients that were held up SOM.

II.2. Measuring priming effect

The isotopic labelling, which permit separating soil C and fresh C mineralization, is the sole current reliable technique to quantify the priming effect.. Other approaches have been proposed to estimate the priming effect when the labelling approach is not possible but the results are highly disputable (Kuzyakov 2010).

In lab incubation studies, *C labelled* simple components of root exudates like glucose, fructose, alanine etc. (Hamer and Marschner 2005) or the extraction of *labelled* plant material like cellulose (Fontaine et al., 2007) or *labelled* plant litter (Conde et al., 2005) is added to *unlabelled* soil. The CO₂ efflux from such soils as well as controls are measured and separated into soil-derived (*unlabelled*) and added-substrate derived (*labelled*) by isotopic mass-balance equations. The difference of soil-derived CO₂ between treated (substrate-added) and control soil is the amount of priming effect. This is very excellent method, easy to control the conditions but it excludes the living roots thus neglecting the rhizospheric processes like rhizodeposition, root absorption of N and root-induced breaking of aggregates.

The measurement of priming in living soil-plant systems is measured by continuous or pulse labelling of plants by exposing them to an atmosphere with constant ratios of ¹⁴C- or ¹³C- CO₂ to total CO₂ over a certain period (Kuzyakov et al., 2001; Dijkstra et al., 2007). The root-derived (*labelled*) and soil-derived (*unlabelled*) CO₂-C is separated from total soil (soil *plus* roots) CO₂ efflux using isotopic mass balance equations. The difference of soil-derived CO₂ between treated (planted) and control soil is the amount of priming effect.

Another method to separate soil-derived and root-derived CO₂ efflux is by using the natural ¹³C abundance of soils and plants. The ¹³C natural abundance method is based on the differential discrimination of the heavier ¹³C isotope during CO₂ assimilation by plants with different types of photosynthesis i.e. C₃ or C₄ plants. The soils developed under C₃ or C₄ vegetation contain SOM with δ¹³C of -27 or 13 ‰ respectively (Cheng 1996). The natural

abundance method is based on cultivation of C_4 on a C_3 or vice versa and estimation of the contribution of root-derived CO_2 according the $\delta^{13}C$ value in the CO_2 evolved.

The current method for measuring soil respiration and hence the priming effect induced by plants can only be used for single-stem plants like tree seedlings or annual plants with strong single stems like sunflower. Indeed, the soil-part must be separated from above ground plant part in order to avoid the assimilation of released soil CO_2 by the plant. To this end, a paraffin wax is applied around stem separating soil and plant compartments (Figure 1.6). The CO_2 efflux from soil (soil *plus* root) is then trapped in an alkali or directly measured by Gas Chromatography Mass Spectrometry (GCMS). This method can not be used for multi-tillered plants like herbaceous species signifying that the priming effect induced by plant grasses is not known.

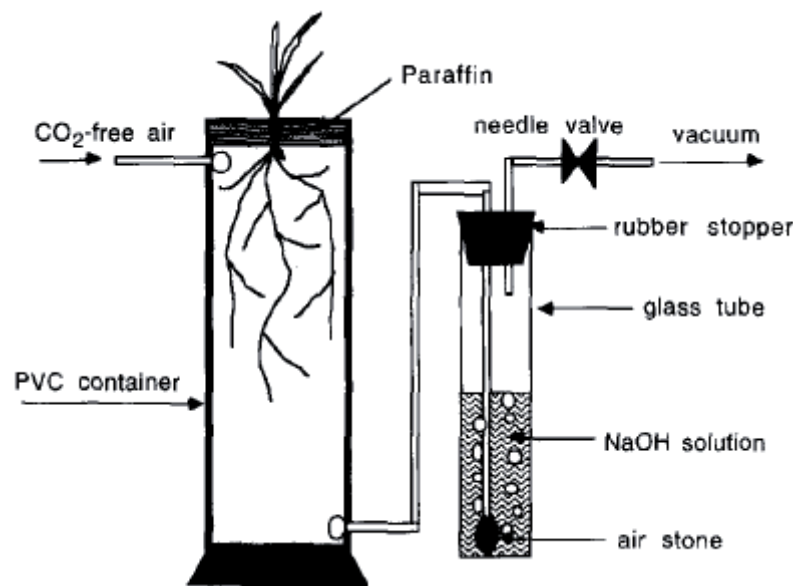

Figure 1.6. The method used to trap soil CO_2 efflux in alkali excluding the trapping of CO_2 from aboveground plant parts. (Cheng 1996).

II.3. Why priming effect is important

Plant roots are an important of organic matter-labile C in the form of exudation, sloughed off roots cells, mucilage collectively called as 'rhizodeposition' and dead root litter-in soil.

Living roots, being a source of labile C, have been found to induce rhizosphere priming effects. The importance of this effect can be gauged from the fact that the increase in SOM mineralization in planted soils can reach to three-fold of SOM mineralization in bare soils under similar temperature and moisture conditions (Zhu and Cheng 2011). RPE have also been shown to induce net C loss from a soil (Fontaine et al., 2004; Dijkstra et al., 2007). Moreover, various biotic and abiotic factors that have been shown to modulate the rate of RPE suggest the importance of studying this phenomenon to devise future strategies for favouring net positive sequestration under living plants and not the net positive SOM mineralization.

Among biotic factors, plant biomass (Dijkstra et al., 2006), photosynthesis (Kuzyakov and Cheng 2001), plant phenology (Fu and Cheng 2002) have been related with rate of RPE. Plant biomass and photosynthesis have been linked with *RPE* suggesting that the increased rate of rhizodeposition under increased plant biomass or photosynthesis increases the rate of RPE (Kuzyakov and Cheng 2001; Dijkstra et al., 2006). For annual plants, it has been shown that the RPE is higher during vegetative growth stages of plant in comparison to reproductive (or later) stages presumably due to high amount of exudation from young roots during early age of plant (Fu and Cheng 2002).

Abiotic factors like soil nutrient status, especially the availability of mineral N has also been found to influence the magnitude of *RPE*. Under high availability of mineral N, lesser amount of priming effect was observed and vice versa (Fontaine et al., 2004a). High availability of N reduces the N limitation and the competition for N between microbial biomass and plant roots. Under high soil fertility the microbes are more adapted to assimilate root exudates as they are less inclined to mineralize high-cost recalcitrant SOM for nutrients when the later are available almost free of cost.

The atmospheric CO₂ levels, soil and air temperature and moisture are expected to change in future climates (IPCC 2007) and all of them have been found to modulate the magnitude of *RPE*. For example, in low fertility soils the sustained growth responses of forest to elevated CO₂ are maintained by enhanced rates of N cycling fuelled by inputs of root-derived exudates and enhanced *RPE* (Phillips et al., 2011). The increased temperature has been found to increase *RPE* suggesting the increased temperature sensitivity of SOM mineralization due to *RPE* (Zhu and Cheng 2011). Higher soil moisture contents (not anaerobic conditions) also facilitate the *RPE* presumably by increased root exudation (Dijkstra and Cheng 2007).

In summary, the future climatic changes that can influence *RPE* directly or indirectly by changing soil nutrient status, soil moisture, biomass production etc. underscore the importance of rhizosphere priming effect and the need to study it.

II.4. Knowledge gaps

The importance of rhizosphere priming effect (RPE) *vis-à-vis* C and N cycles in grasslands is not clear owing perhaps to the absence of a method to directly measure RPE induced by grasses. After detailed literature review, six knowledge gaps were identified to work on for this thesis:

What is the effect of grazing on RPE? Grazing is central to the management of grasslands and has been shown to accelerate the decomposition of plant litter present in soil (Klumpp et al., 2009). However, the effect of grazing on mineralization of SOM is unclear. The increased availability of soluble C, higher net N mineralization and increased microbial biomass in soil after clipping the plant leaves were considered an evidence to suggest that the plant clipping could accelerate SOM mineralization i.e. increased *RPE* thereby releasing mineral N from recalcitrant SOM for plant uptake (Hamilton and Frank 2001). If this hypothesis is true, then clipping (a simulation of mowing or grazing *minus* animal excreta)

could decrease soil C stocks on two fronts i.e. first, due to reduced overall C input into soil due to reduced aboveground production and rhizodeposits and second, by stimulating the mineralization of already existing soil C (SOM). However, the studies where soil CO₂ efflux was measured after plant clipping do not support the hypothesis of increased *RPE* after plant clipping. In contrast, these studies have shown that the plant clipping can reduce soil CO₂ efflux by 20-50 % (Craine et al., 1999; Bahn et al., 2006). Thus, the impact of grazing on recalcitrant soil organic matter must be studied through a direct approach.

Are plants with deep roots able to reactivate deep ancient C and N cycle through a priming effect? The SOM mineralization has been found to accelerate in the presence of living roots of annual plants and tree seedlings (Cheng et al., 2003; Dijkstra et al., 2007) and in some cases to result in net soil C loss (Dijkstra et al., 2007). Most of the studies aiming to find out the effect of living roots on soil C stocks and soil-derived CO₂ efflux are limited to upper 20 or 30 cm of soil. However, of the 1600 Gt of organic C held in the top meter of world soils, about half is in the 25-100 cm layer (Jobbàgy and Jackson 2000). Moreover, some recent studies focussing on C sequestration in soils have suggested that deep soils may not be sequestering C or even losing some of it (Carter 2005). The C loss from deep soils suggests that the labile C deposition may be accelerating the mineralization of deep soil C. A recent study in lab conditions (Fontaine et al., 2007) have actually shown that the labile C addition to soil sampled from deep soil (80 cm depth) could accelerate SOM mineralization and destabilize ~ 2500 years old C. The SOM dynamics in deep soils in the presence of living roots is an important question to study to predict its feedbacks as well as viability of deep soil for C sequestration in future climates in which temperatures have been predicted to rise.

Is global warming going to intensify the priming effect leading to soil C losses? The SOM mineralization being an enzymatic reaction is supposed to be influenced by temperature and its relationship with temperature has been described using Arrhenius equation by a

number of studies. According to Arrhenius (1889) most of chemical reactions need a ‘little push’ in the form of exogenous energy to proceed, which he called activation energy. In a reaction, higher the fraction of reactants having required activation energy or more, the higher will be the rate of that reaction. Moreover, higher the activation energy of a reaction higher will be the temperature response of that reaction. For example, chemically more recalcitrant organic compounds need higher activation energy to proceed for mineralization thus will show stronger temperature response as compared to relatively labile organic compounds (Bosatta and Agren 1999). A lot of lab incubation studies have shown the increase in SOM mineralization with increasing temperature as predicted in Arrhenius equation (Kirschbaum 1995; Waldrop and Firestone 2004; Knorr et al., 2005). However, the results of long term soil warming field experiments (in the presence of plants) do not always support this theoretical prediction and the results of lab incubations. They show that the mineralization of recalcitrant SOM may acclimatize to temperature increase in the long term (Luo et al., 2001; Melillo et al., 2002; Eliasson et al. 2005; Bradford et al., 2008). One reason for this discrepancy between lab and field experiments’ results may lie in the omission of rhizospheric processes, i.e. consistent supply of labile C substrate and rhizosphere priming effect, in lab incubation studies. It should be noted that the effect of priming effect on SOM mineralization is known to be higher than the effect of temperature (Hoosbeek et al., 2004). Moreover, the warm temperatures (for example summer season) stimulate photosynthesis, plant biomass production and C inputs into the soil with possibility of increasing *RPE*. However, to date the reports on the direct effects of temperature on *RPE* are scarce.

How do plant growth strategies affect plant-soil interactions and the priming effect?

Various plant species varying with respect to the quantity of rhizodeposits have been shown to modify soil C stocks in varying amounts (Dijkstra et al., 2006 b). The chemistry of root litter has also been linked to the dynamics of SOM. Specifically, root N concentration across

species was significantly negatively related to decomposition of soil C. Moreover various plant species, especially grassland species, vary in nitrogen uptake and the duration for which they conserve this nitrogen in their biomass by controlling the amount of rhizodeposits thereby imposing certain negative mineral N balance in soil. The quantity and quality of rhizodeposits and the duration for which negative mineral N balance is induced in soil by various species could induce varying amounts of *RPEs* thereby altering soil C stocks.

Can legumes foster C storage in soils by lowering the priming effect? The availability of mineral N can modify the interaction between incoming labile organic matter and recalcitrant SOM (Section 1.1.3, 1.2.3). In lab conditions, it has been shown that under higher availability of mineral N the amount of *RPE* was less as compared to that under lower N availability for similar supplies of labile organic matter. Moreover high fertility stabilized more added-C than low fertility. Could the similar results be produced under living plants where high N availability will stimulate higher production of plant biomass and rhizodeposits? Moreover, is the natural availability of mineral nitrogen under N-fixing plants capable of stabilizing more C deposited by N-fixing as well as a co-occurring non N-fixing plant? The inter-play of amount and quality of rhizodeposits and soil fertility is yet to be determined vis-à-vis *RPE* and soil C stocks.

What is the relative contribution of root exudates, mycorrhizae and root litter depositions in the priming effect induced by plants? The rhizodeposits can loosely be divided into three major components: root exudates, mycorrhizae and root litter. Among them root litter has been shown to induce the *RPE*. The mycorrhizae have been shown to accelerate the mineralization of labelled plant litter and obtain mineral N for their host plant (Hodge et al., 2001). However, we do not know if they can induce SOM mineralization as well. For root exudates, it is assumed that they can induce *RPE* based on lab incubations where various components of root exudates singly or in combinations were added in a soil and priming

effect determined (Hamer and Marschner 2005). However, certain components of root exudates do not accelerate the mineralization of SOM (Dalenberg, 1981, 1989; Hamer and Marschner 2005) in these experiments and no evidence of *RPE* under living plants exclusively by exudates is available. Actually, it is uncertain if they can stimulate SOM mineralizing microbes or they are readily used up by that group of microbes which is capable of mineralizing the 'too' labile organic C only.

Soil microbes, the drivers of *RPE* are perhaps the least known component of the *RPE* phenomenon. We shall discuss briefly our knowledge or lack thereof about the microbes involved in *RPE* in succeeding section.

Which soil microbes 'prime' the SOM mineralization? The question as to which microbes are responsible for mineralization of recalcitrant SOM is still an open one and closely linked with priming effect mechanisms. Fontaine et al. (2003) suggested that microbial groups are specialized in using organic substrate on the basis of their ability to acquire mineral nutrients and can be divided into two groups: r-strategists and k-strategists. While both of them are energy limited in soil and can use the labile C, r-strategists are quicker to assimilate labile substrates than their competitors. However, k-strategists boosted by the energy obtained from labile C can mine recalcitrant SOM for mineral nutrients and more C thereby inducing the *RPE*. Recently it has been suggested that it is fungi are the main actors in priming effect (Fontaine et al., 2011). It has been suggested that the fungi specialize in accessing and degrading substrates that are poorly available to most bacteria and, in contrast to bacteria, can grow through low nutrient zones to the distantly located substrates using their hyphae (Otten et al., 2001). However, as shown by ^{13}C -PLFA, Gram-negative bacteria may also contribute to priming effect (Nottingham et al., 2009). Most of priming studies are short term (a few weeks to couple of months) and only a very few (Blagodatskaya et al., 2007; Marx et al., 2007) have examined the dynamics and activity of microbial groups over an extended period.

We know that *RPE* can last for over a year (Dijkstra et al., 2007) however we do not know which microbial groups are involved in *RPE*. A large number of microbial groups may be involved. Nevertheless, the study of microbial communities in a soil-plant system adopting a correlative approach could help identify the microbial groups that play key role in priming effect.

III. Objectives of thesis

The principal objective of this thesis is to contribute to the knowledge of mechanisms controlling the priming effect and hence the long-term soil organic matter dynamics in grasslands. From an applied perspective, this work aims at identifying key biological mechanisms that could be used to increase the C storage and the efficiency of forage production (more primary production with less mineral fertilizers) in permanent grasslands. On the basis of contradictions and knowledge gaps found in literature (Section 1.2), we formulated some hypotheses which provided the base for the research work carried for this thesis.

III.1. Hypotheses of thesis

In the first experiment, we wanted to test the effect of plant clipping on SOM mineralization. We hypothesized that the plant clipping would decrease rhizosphere priming effect by decreasing the supply of labile C to mycorrhizae and soil microbes. We also assumed that clipping would reduce total plant N uptake due to curtailed photosynthesis thereby increasing mineral N quantity in soil. Moreover, reduced photosynthesis and decreased labile C supply after clipping was expected to change microbial community structure with the relative abundance of saprophytic fungi expected to follow the change in *RPE*.

In the second experiment, we tested the effect of a deep-rooted plant on the SOM dynamics in deep soil. We assumed that the deep soil microbes are energy limited like their

counterparts in surface soils and are capable of accelerating SOM mineralization i.e. inducing *RPE* in the presence of living roots by using labile C coming from roots. Moreover, the accelerated SOM mineralization in the presence of living roots was expected to increase nitrogen mineralization. Microbial community structure especially relative abundance of saprophytic fungi was expected to correspond with the amount of *RPE*.

For the question of effect of temperature on *RPE*, we theorized that when specific enzyme activity, time and temperature dependent enzyme inactivation and microbial production of enzyme in the presence of fresh supply of labile C (e.g. in the presence of living roots) is taken into account, SOM mineralization would have a negative relationship with temperature. This theoretical framework was then validated by measuring short term (24 hours) temperature treatments as well as seasonal temperature response of *RPE* under living plants in a mesocosm.

To test the effect of different grassland species producing varying quantity and quality of rhizodeposits and the mineral nitrogen balance in soil they impose, six gramineae and one legume commonly found in temperate grasslands were selected. It was hypothesized that the quick growing species would induce strong amounts of *RPEs* in early periods while slow growing species would induce lower amounts of *RPEs* early on and strong *RPEs* in the later stages. Moreover, the leguminous species would induce important amounts of *RPEs* though it would stock more C than it would mineralize.

In another experiment, the possibility of high C stocks and lower *RPE* under high availability of nitrogen, through mineral fertilizers or natural N fixation by an N-fixing plant, was tested. It was hypothesized that under high availability of mineral N the microbial mineralization of SOM would decrease since the microbial need to acquire N from SOM would lessen due to supply of mineral N.

Lastly, the hypothesis that root exudates from living roots are capable of stimulating the soil microbes and accelerating SOM mineralization thereby inducing *RPE* was tested. In addition, the contribution of each component of rhizodeposition i.e. roots, mycorrhizae and root exudates in inducing *RPE* was estimated.

III.2. Approaches of the study

The most original part of approaches developed in the thesis are presented here:.

a. Experimental approach

A dual labelling (^{13}C and ^{14}C) of fresh material is needed for quantifying the priming effect and the age of soil C released by this priming (Fontaine et al., 2007). Therefore, we set up a labelling system permitting a continuous dual labelling of grassland plants in a mesocosm where plants benefited from natural light and temperature. A schematic diagram of the labelling system and picture of the mesocosm containing the planted and unplanted pots are shown in Figure 1.7. A screw compressor, a self-regenerating adsorption dryer capable of generating decarbonised air at a rate of up to 5000 standard liters per minute (SLPM) and residual CO_2 below $1\mu\text{mol CO}_2 \text{ mol}^{-1}$ air, an air reservoir, gas cylinders containing fossil fuel derived CO_2 and a humidifier ($1\text{m}^3:1\text{m}^2$ cross corrugated cellulose pads) constitute the main parts of the labeling system. Ambient air was taken into the system by a compressor, its CO_2 and H_2O contents and all other particles were scrubbed by a molecular sieve. This decarbonised air was then mixed with fossil-originated CO_2 which is naturally depleted in ^{13}C and ^{14}C . A mass flow meter served to control the CO_2 injection rate. Flow rate of the whole system was controlled by pressure regulators. During daytime, around 30 % of decarbonised dry air was diverted to one of the two molecular sieves in order to regenerate it. Therein, regeneration of molecular sieve was done every six minutes. There was no labeling during nighttime. Planted and bare soil pots were placed in mesocosm on April 1, 2009 and remained there till the end of experiment. The concentration of CO_2 in the mesocosm was

maintained at 400 ± 20 ppm. The air in mesocosm was renewed twice a minute to avoid the uptake of soil-derived (*unlabelled*) CO_2 by plants. The relative humidity within the mesocosm was maintained around 50-60 %.

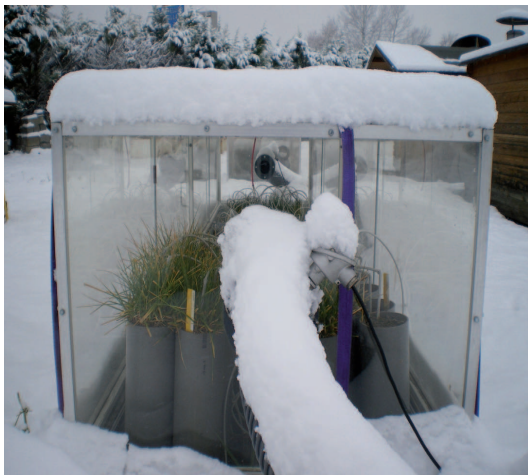
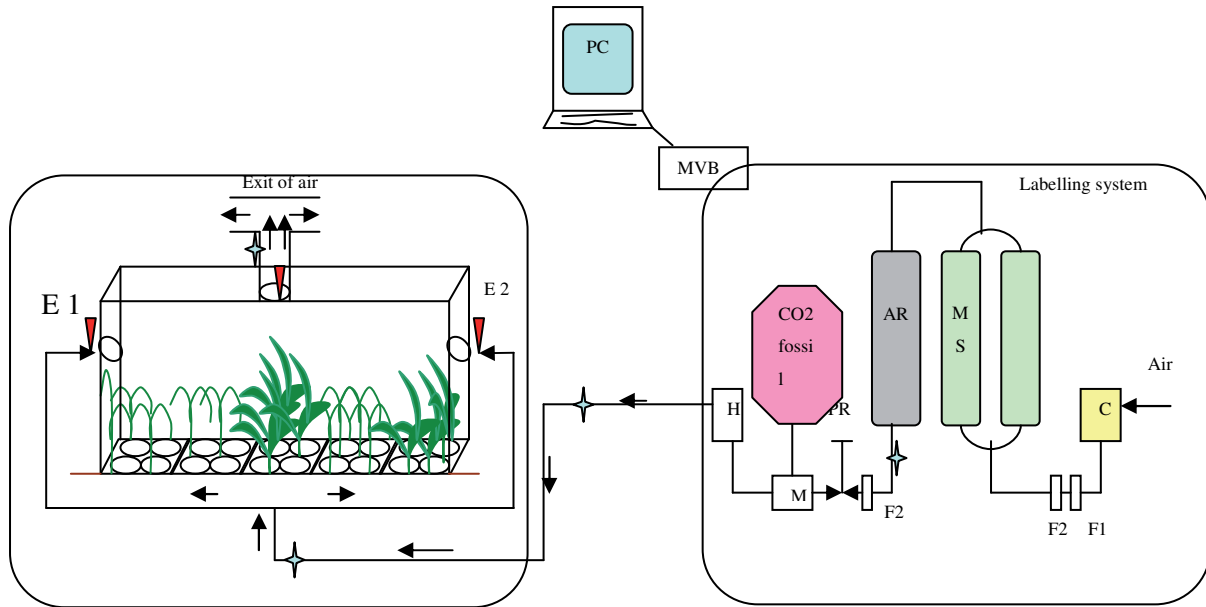

Figure 1.7. The scheme of labelling system and mesocosm (above). Pictures of mesocosm containing plants (below). C Compressor: MS, Molecular sieve: AR, Air reservoir: F1, oil & water extraction: F2, oil, water & particle filter

As discussed earlier (section 1.2.2, Figure 1.6), the current method for measuring soil respiration and hence the priming effect induced by plants can only be used for single-stem plants. Therefore, we conceived a novel method to measure *RPE* induced by herbaceous plant. To this end, planted soil pot as well as bare-soil pots (40 cm height, Ø 9.8 cm) were put into opaque respiration chambers (100 cm height, Ø 15 cm) (Figure 1.8). The absence of light in respiration chambers stopped the photosynthesis and avoided re-assimilation of soil-derived CO₂ (*unlabelled*) by plants. The respiration chambers were tightly sealed and placed under shade for 24 hours. An alkali solution (200 ml of 1M NaOH) was placed into respiration chambers to trap the CO₂ released by the plant-soil system. Preliminary tests showed that 99% of CO₂ respired by soil-plant system is trapped by the alkali solution. The CO₂ trapped in NaOH was measured with a total inorganic-C analyzer. The ¹³C abundance of trapped CO₂ was analyzed with an Isotope-Ratio Mass Spectrometer (IRMS) after precipitating the carbonates with excess BaCl₂ and filtration. Isotopic labeling allowed the separation of soil-derived CO₂-C from plant-derived CO₂-C using classical balance mass equations (See chapters 2 for details). In order to calculate the rhizosphere priming effect (RPE), CO₂-C released by bare soils was subtracted from soil-derived CO₂-C released by planted soils.

To determine the effect of living roots on SOM mineralization in deep soil layers, intact soil columns were sampled from 10-80 cm soil depth and placed into PVC pots (Height 70 cm, Ø 9.8 cm) without disturbing their structure. A grassland species, *Festuca arundinacea*, known for producing deep roots was sown and cultivated under dual labelled CO₂. The ¹³C labelling permitted separation of soil-derived CO₂ from plant-derived CO₂ whereas ¹⁴C labelling allowed calculating the age of CO₂-C. The RPE was measured for whole soil-plant system for almost one and half year.

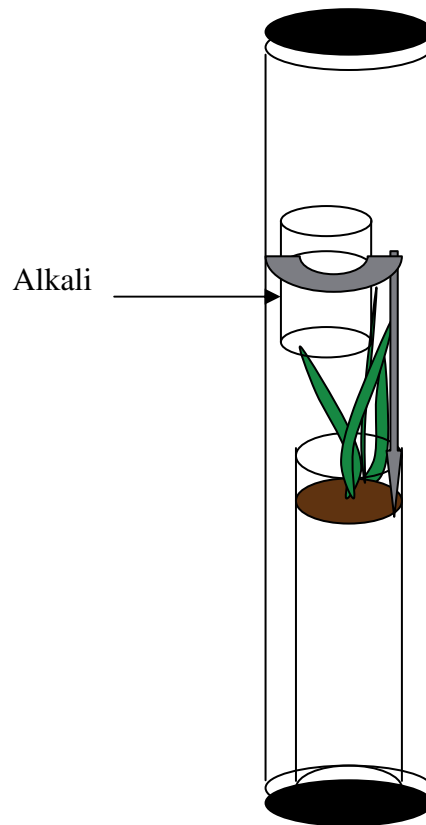

Figure 1.8. Respiration chamber to measure RPE in herbaceous plants

Then, the PVC tubes- were cut horizontally into three parts corresponding to the three soil horizons 10-33 cm, 33-56 cm and 56-80 cm. These three horizons were separately incubated to quantify the *RPE* and the age of soil C released by the RPE (See Chapter 3 for more details).

In order to decouple the effects of root exudates, mycorrhizae and roots on soil organic C, a novel experiment was put into place. Soil, sampled from temperate grassland, was put into PVC cylinders whose cross sections were closed with 0.45 μm , 30 μm or 1000 μm mesh. Four cylinders of a particular mesh (about 60 g soil) were buried in inert sand in a pot. Three grassland plants i.e. *Lolium perenne*, *Poa trivialis* and *Trifolium repens* were grown on these pots and continuously labelled with ^{13}C depleted air in a mesocosm. The soil cylinders (1000 μm) placed in unsown sand pots were used as controls. The 0.45 μm mesh was permeable

only to root exudates thus corresponding to the effect of root exudates on SOC (RE treatment), 30 μ m mesh was permeable to root exudates and mycorrhizae representing the effect of root exudates and mycorrhizae (RE+Myc treatment) and 1000 μ m mesh being permeable to root exudates, mycorrhizae and roots represented the combined effect of all of them (Whole-root treatment). The respiration from plant-soil system was measured periodically as described earlier.

b) Theoretical approach

The relationship between temperature and SOM mineralization was explored by developing a novel theoretical framework and then validating the prediction of the theory with experiment results. The model includes two key processes that are usually omitted which are often overlooked while modeling or describing the experimental results of effect of temperature on enzymatic activities and organic matter mineralization. First, microbial decomposers are limited by fresh energy-rich C which controls their enzyme production capability to mineralize recalcitrant C in soil. Second, enzyme inactivation, occurring due to loss of three dimensional structures of enzymes induced by the Brownian movement, accelerates with warming. The analysis of the model in dynamic and at steady state stress on the need of separating non steady-state-system like incubated bare soil wherein there is a continuous decrease in enzymatic pool, from a steady-state-system where the enzymatic pool is maintained by microbes which are supplied with fresh C like in soil-plant system. The model predicts that soil C mineralization should increase with temperature till an optimum in bare soil whereas it should continuously decrease with temperature in planted soil. These predictions were confirmed by an experiment on planted soil and bare soil systems submitted to seasonal temperature variation for 479 days.

IV. Thesis layout

During the experiment phase of this thesis, six hypotheses were made and consequently tested with six experiments. However in this manuscript three are presented in the form of finished articles and three others, for which only preliminary results are available at this stage, have been assembled in chapter 5 under the heading ‘articles in preparation’.

This chapter of introduction is preceded by four chapters discussing the results of original research work.

First finished article describes the effect of plant clipping on SOM mineralization, mineral N availability, soil microbial biomass and microbial community structure (Chapter 2, pages 37-66). This article has already been accepted in ‘*Soil Biology & Biochemistry*’ with minor corrections.

Second article describes the effect of rhizodeposition by living roots on mineralization of SOM in deep soils and microbial community along the soil profile. Moreover, this study aims to identify the microbes involved in SOM mineralization and rhizosphere priming effect (Chapter 3, pages 67-97).

Third article is about the relationship of temperature with SOM mineralization (Chapter 4, pages 98-129).

Fifth chapter assembles the preliminary results of three experiments under the heading ‘*Articles in preparation*’ (pages 130-146).

A general discussion and perspectives emanating from the thesis make up the last chapter of this work (pages 147-160).

An annexe containing a novel work on acellular respiration in soils in which this doctorate student participated is attached in the end.

V. References

- Arrhenius, S. 1889. Uber die Reaktionsgeschwindigkeit bei der Inversion von Rohrzucker durch Sauren. *Zeitschrift fuer physikalische Chemie* 4, 226-248.
- Bahn, M., Knapp, M., Garajova, Z., Pfahringer, N., Cernusca, A., 2006. Root respiration in temperate mountain grasslands differing in land use. *Global Change Biology* 12, 995-1006.
- Batjes, N.H., 1996. Total carbon and nitrogen in the soils of the world. *European Journal of Soil Science* 47, 151-163.
- Bingeman, C.W., Varner, J.E., Martin, W.P., 1953. The effect of the addition of organic materials on the decomposition of an organic soil. *Soil Science Society of America Journal* 17, 34-38.
- Blagodatskaya, E.V., Blagodatsky, S.A., Anderson, T.H., Kuzyakov, Y., 2007. Priming effects in Chernozem induced by glucose and N in relation to microbial growth strategies. *Applied Soil Ecology* 37, 95-105.
- Blagodatskaya, E., Kuzyakov, Y., 2008. Mechanisms of real and apparent priming effects and their dependence on soil microbial biomass and community structure: critical review. *Biology and Fertility of Soils* 45, 115-131.
- Bosatta, E., Ågren, G.I., 1999. Soil organic matter quality interpreted thermodynamically. *Soil Biology and Biochemistry* 31, 1889-1891.
- Bradford, M.A., Davies, C.A., Frey, S.D., Maddox, T.R., Melillo, J.M., Mohan, J.E., Reynolds, J.F., Treseder, K.K., Wallenstein, M.D., 2008. Thermal adaptation of soil microbial respiration to elevated temperature. *Ecology Letters* 11, 1316-1327.
- Broadbent, F.E. and Norman, A.G. 1946. Some factors affecting the availability of the organic nitrogen in soil-A preliminary report. *Soil science society of America Journal*. DOI: 10.2136/sssaj1947.036159950011000C0050x.

- Carter, M.R., Gregorich, E.G., Carbon and nitrogen storage by deep-rooted tall fescue (*Lolium arundinaceum*) in the surface and subsurface soil of a fine sandy loam in eastern Canada. *Agriculture, Ecosystems & Environment* 136, 125-132.
- Cheng, W., 1996. Measurement of rhizosphere respiration and organic matter decomposition using natural ^{13}C . *Plant and Soil* 183, 263-268.
- Cheng, W., Johnson, D.W., Fu, S., 2003. Rhizosphere effects on decomposition: controls of plant species, phenology, and fertilization. *Rhizosphere Effects on Decomposition*. Soil Science Society of America Journal 67, 1418-1427.
- Chenu, C., Plante, A.F., 2006. Clay-sized organo-mineral complexes in a cultivation chronosequence: revisiting the concept of the 'primary organo-mineral complex'. *European Journal of Soil Science* 57, 596-607.
- Chenu, C. and Stotzky, G. 2002. Interactions between microorganisms and soil particles: an overview. *In Interactions Between Soil Particles and Microorganisms*. Eds. Huang, P.M. Bollag, J.M. and Senesi, N. pp. 3-40. Wiley and Sons, New York.
- Coleman, K., Jenkinson, D.S., Crocker, G.J., Grace, P.R., Klir, J., Körschens, M., Poulton, P.R., Richter, D.D., 1997. Simulating trends in soil organic carbon in long-term experiments using RothC-26.3. *Geoderma* 81, 29-44.
- Conde, E., Cardenas, M., Ponce-Mendoza, A., Luna-Guido, M.L., Cruz-Mondragón, C., Dendooven, L., 2005. The impacts of inorganic nitrogen application on mineralization of ^{14}C -labelled maize and glucose, and on priming effect in saline alkaline soil. *Soil Biology and Biochemistry* 37, 681-691.
- Craine, J., Wedin, D., Chapin, F., 1999. Predominance of ecophysiological controls on soil CO_2 flux in a Minnesota grassland. *Plant and Soil* 207, 77-86.

- Christensen, B.T., 1996. Carbon in primary and secondary organomineral complexes. *In* Structure and Organic Matter storage in Agricultural Soils. Eds. M.R. Carter and B.A. Stewart, page 97-165. CRC Press, Inc. Boca Raton, FL.
- Dalenberg, J.W., Jager, G., 1981. Priming effect of small glucose additions to ¹⁴C-labelled soil. *Soil Biology and Biochemistry* 13, 219-223.
- Dalenberg, J.W., Jager, G., 1989. Priming effect of some organic additions to ¹⁴C-labelled soil. *Soil Biology and Biochemistry* 21, 443-448.
- Davidson, E.A., Janssens, I.A., 2006. Temperature sensitivity of soil carbon decomposition and feedbacks to climate change. *Nature* 440, 165-173.
- Dijkstra, F.A., Cheng, W., 2007a. Interactions between soil and tree roots accelerate long-term soil carbon decomposition. *Ecology Letters* 10, 1046-1053.
- Dijkstra, F.A., Cheng, W., 2007b. Moisture modulates rhizosphere effects on C decomposition in two different soil types. *Soil Biology and Biochemistry* 39, 2264-2274.
- Dijkstra, F.A., Cheng, W., Johnson, D.W., 2006a. Plant biomass influences rhizosphere priming effects on soil organic matter decomposition in two differently managed soils. *Soil Biology and Biochemistry* 38, 2519-2526.
- Dijkstra, F.A., Hobbie, S.E., Reich, P.B., 2006b. Soil Processes Affected by Sixteen Grassland Species Grown under Different Environmental Conditions. *Soil Science Society of America Journal*. 70, 770-777.
- Edwards, A.P., Bremner, J.M., 1967. Microaggregates in soils-1. *Journal of Soil Science* 18, 64-73.
- Eliasson, P.E., McMurtrie, R.E., Pepper, D.A., Strömberg, M., Linder, S., Ågren, G.I., 2005. The response of heterotrophic CO₂ flux to soil warming. *Global Change Biology* 11, 167-181.

- Elliott, E.T., Aggregate structure and carbon, nitrogen, and phosphorus in native and cultivated soils. *Soil Science Society of America Journal* 50, 627-633.
- Fagerbakke, K.M., Haldal, M., Norland, S., 1996. Content of carbon, nitrogen, oxygen, sulfur and phosphorus in native aquatic and cultured bacteria. *Aquatic Microbial Ecology* 10, 15-27.
- Fontaine, S., Bardoux, G., Abbadie, L., Mariotti, A., 2004a. Carbon input to soil may decrease soil carbon content. *Ecology Letters* 7, 314-320.
- Fontaine, S., Bardoux, G., Benest, D., Verdier, B., Mariotti, A., Abbadie, L., 2004b. Mechanisms of the Priming Effect in a Savannah Soil Amended with Cellulose. *Soil Science Society of America Journal* 68, 125-131.
- Fontaine, S., Barot, S., 2005. Size and functional diversity of microbe populations control plant persistence and long-term soil carbon accumulation. *Ecology Letters* 8, 1075-1087.
- Fontaine, S., Barot, S., Barre, P., Bdioui, N., Mary, B., Rumpel, C., 2007. Stability of organic carbon in deep soil layers controlled by fresh carbon supply. *Nature* 450, 277-280.
- Fontaine, S., Henault, C., Aamor, A., Bdioui, N., Bloor, J.M.G., Maire, V., Mary, B., Revaillet, S., Maron, P.A., 2011. Fungi mediate long term sequestration of carbon and nitrogen in soil through their priming effect. *Soil Biology and Biochemistry* 43, 86-96.
- Fontaine, S., Mariotti, A., Abbadie, L., 2003. The priming effect of organic matter: a question of microbial competition? *Soil Biology and Biochemistry* 35, 837-843.
- Fu, S., Cheng, W., 2002. Rhizosphere priming effects on the decomposition of soil organic matter in C4 and C3 grassland soils. *Plant and Soil* 238, 289-294.

- Hamer, U., Marschner, B., 2005. Priming effects in different soil types induced by fructose, alanine, oxalic acid and catechol additions. *Soil Biology and Biochemistry* 37, 445-454.
- Hamilton, E.W., Frank, D.A., 2001. Can plants stimulate soil microbes and their own nutrient supply? Evidence from a grazing tolerant grass. *Ecology* 82, 2397-2402.
- Hodge, A., Campbell, C.D., Fitter, A.H., 2001. An arbuscular mycorrhizal fungus accelerates decomposition and acquires nitrogen directly from organic material. *Nature* 413, 297-299.
- Hoosbeek, M.R., Lukac, M., van Dam, D., Godbold, D.L., Velthorst, E.J., Biondi, F.A., Peressotti, A., Cotrufo, M.F., de Angelis, P., Scarascia-Mugnozza, G., 2004. More new carbon in the mineral soil of a poplar plantation under Free Air Carbon Enrichment (POPFACE): Cause of increased priming effect? *Global Biogeochemical Cycles* 18, GB1040.
- Houghton, R.A., 2005. Aboveground forest biomass and the global carbon balance. *Global Change Biology* 11, 945-958.
- Hungate, B.A., Van Groenigen, K.-J., Six, J., Jastrow, J.D., Luo, Y., De Graaff, M.-A., Van Kessel, C., Osenberg, C.W., 2009. Assessing the effect of elevated carbon dioxide on soil carbon: a comparison of four meta-analyses. *Global Change Biology* 15, 2020-2034.
- IPCC, 2007. *Climate Change 2007 : Synthesis Report. Contributions of working groups I, II and III to the Fourth Assessment Report of the Intergovernmental Panel on Climate Change.* In, IPCC, Geneva.
- Jastrow, J.D., 1996. Soil aggregate formation and the accrual of particulate and mineral-associated organic matter. *Soil Biology and Biochemistry* 28, 665-676.

- Jastrow, J.D., Michael Miller, R., Matamala, R., Norby, R.J., Boutton, T.W., Rice, C.W., Owensby, C.E., 2005. Elevated atmospheric carbon dioxide increases soil carbon. *Global Change Biology* 11, 2057-2064.
- Jenkinson, D.S., Fox, R.H., Rayner, J.H., 1985. Interactions between fertilizer nitrogen and soil nitrogen—the so-called ‘priming’ effect. *Journal of Soil Science* 36, 425-444.
- Jobbagy, E.G., Jackson, R.B., 2000. The vertical distribution of soil organic carbon and its relation to climate and vegetation. *Ecological Applications* 10, 423-436.
- Kirschbaum, M.U.F., 1995. The temperature dependence of soil organic matter decomposition, and the effect of global warming on soil organic C storage. *Soil Biology and Biochemistry* 27, 753-760.
- Kirschbaum, M.U.F., 2004. Soil respiration under prolonged soil warming: are rate reductions caused by acclimation or substrate loss? *Global Change Biology* 10, 1870-1877.
- Klumpp, K., Fontaine, S., Attard, E., Le Roux, X., Gleixner, G., Soussana, J.-F., 2009. Grazing triggers soil carbon loss by altering plant roots and their control on soil microbial community. *Journal of Ecology* 97, 876-885.
- Knorr, W., Prentice, I.C., House, J.I., Holland, E.A., 2005. Long-term sensitivity of soil carbon turnover to warming. *Nature* 433, 298-301.
- Kuzyakov, Y., Cheng, W., 2001. Photosynthesis controls of rhizosphere respiration and organic matter decomposition. *Soil Biology & Biochemistry* 32, 1915-1925.
- Kuzyakov, Y., Ehrensberger, H., Stahr, K., 2001. Carbon partitioning and below-ground translocation by *Lolium perenne*. *Soil Biology & Biochemistry* 33, 61-74.
- Kuzyakov, Y., 2010. Priming effects: Interactions between living and dead organic matter. *Soil Biology and Biochemistry* 42, 1363-1371.
- Löhnis, F., 1926. Nitrogen Availability of Green Manures. *Soil Science* 22, 253-290.

- Luo, Y., Wan, S., Hui, D., Wallace, L.L., 2001. Acclimatization of soil respiration to warming in a tall grass prairie. *Nature* 413, 622-625.
- Lützow, M.v., Kögel-Knabner, I., Ekschmitt, K., Matzner, E., Guggenberger, G., Marschner, B., Flessa, H., 2006. Stabilization of organic matter in temperate soils: mechanisms and their relevance under different soil conditions – a review. *European Journal of Soil Science* 57, 426-445.
- Marx, M., Buegger, F., Gattinger, A., Marschner, B., Zsolnay, Á., Munch, J.C., 2007. Determination of the fate of ^{13}C labelled maize and wheat rhizodeposit-C in two agricultural soils in a greenhouse experiment under ^{13}C -CO₂-enriched atmosphere. *Soil Biology and Biochemistry* 39, 3043-3055.
- Melillo, J.M., Steudler, P.A., Aber, J.D., Newkirk, K., Lux, H., Bowles, F.P., Catricala, C., Magill, A., Ahrens, T., Morrisseau, S., 2002. Soil warming and carbon-cycle feedbacks to the climate system. *Science* 298, 2173-2176.
- Merckx, R., den Hartog, A., van Veen, J.A., 1985. Turnover of root-derived material and related microbial biomass formation in soils of different texture. *Soil Biology and Biochemistry* 17, 565-569.
- MEA, Millennium Ecosystem Assessment-Nutrient Cycling. World Resource Institute, Washington DC (2005).
- Nottingham, A.T., Griffiths, H., Chamberlain, P.M., Stott, A.W., Tanner, E.V.J., 2009. Soil priming by sugar and leaf-litter substrates: A link to microbial groups. *Applied Soil Ecology* 42, 183-190.
- Otten, W., Hall, D., Harris, K., Ritz, K., Young, I.M., Gilligan, C.A., 2001. Soil physics, fungal epidemiology and the spread of *Rhizoctonia solani*. *New Phytologist* 151, 459-468.

- Parton, W.J., Schimel, D.S., Cole, C.V., Ojima, D.S., 1987. Analysis of factors controlling soil organic-matter levels in great-plains grasslands. *Soil Science Society of America Journal* 51, 1173-1179.
- Petit, J.R., Jouzel, J., Raynaud, D., Barkov, N.I., Barnola, J.M., Basile, I., Bender, M., Chappellaz, J., Davis, M., Delaygue, G., Delmotte, M., Kotlyakov, V.M., Legrand, M., Lipenkov, V.Y., Lorius, C., Pepin, L., Ritz, C., Saltzman, E., Stievenard, M., 1999. Climate and atmospheric history of the past 420,000 years from the Vostok ice core, Antarctica. *Nature* 399, 429-436.
- Phillips, R.P., Finzi, A.C., Bernhardt, E.S., 2011. Enhanced root exudation induces microbial feedbacks to N cycling in a pine forest under long-term CO₂ fumigation. *Ecology Letters* 14, 187-194.
- Reich, P.B., Hobbie, S.E., Lee, T., Ellsworth, D.S., West, J.B., Tilman, D., Knops, J.M.H., Naeem, S., Trost, J., 2006. Nitrogen limitation constrains sustainability of ecosystem response to CO₂. *Nature* 440, 922-925.
- Schlesinger, W.H., 1990. Evidence from chronosequence studies for a low carbon-storage potential of soils. *Nature* 348, 232-234.
- Schlesinger, W.H. 1997. *Biogeochemistry: An Analysis of Global Change*. Academic Press, New York, ed. 2)
- Schlesinger, W.H., Andrews, J.A., 2000. Soil respiration and the global carbon cycle. *Biogeochemistry* 48, 7-20.
- Siegenthaler, U., Stocker, T.F., Monnin, E., Lüthi, D., Schwander, J., Stauffer, B., Raynaud, D., Barnola, J.-M., Fischer, H., Masson-Delmotte, V.r., Jouzel, J., 2005. Stable Carbon Cycle–Climate Relationship During the Late Pleistocene. *Science* 310, 1313-1317.

- Six, J., Conant, R.T., Paul, E.A., Paustian, K., 2002. Stabilization mechanisms of soil organic matter: Implications for C-saturation of soils. *Plant and Soil* 241, 155-176.
- Sorensen, L.H., 1972. Stabilization of newly formed amino acid metabolites in soil by clay minerals. *Soil Science* 114, 5-11.
- Sterner, W.R. and Elser J.J. 2002. *Ecological Stoichiometry: The Biology of Elements From Molecules to the Biosphere*. Princeton University Press, 41, William Street, Princeton, New Jersey.
- Stevenson, F.J., 1994. *Humus Chemistry: Genesis, Composition, Reactions*. John Wiley & Sons, New York.
- Syers, J.K., Adams, J.A., Walker, T.W., 1970. Accumulation of organic matter in a chronosequences of soils developed on wind-blown sand in New Zealand. *Journal of Soil Science* 21, 146- 153.
- van Groenigen, K.-J., Six, J., Hungate, B.A., de Graaff, M.-A., van Breemen, N., van Kessel, C., 2006. Element interactions limit soil carbon storage. *Proceedings of the National Academy of Sciences* 103, 6571-6574.
- Waldrop, M.P., Firestone, M.K., 2004. Altered utilization patterns of young and old soil C by microorganisms caused by temperature shifts and N additions. *Biogeochemistry* 67, 235-248.
- Wutzler, T., Reichstein, M., 2008. Co-limitation of decomposition by substrate and decomposers - a comparison of model formulations. *Biogeosciences* 5, 749-759.
- Zhu, B., Cheng, W., 2011. Rhizosphere priming effect increases the temperature sensitivity of soil organic matter decomposition. *Global Change Biology* 17, 2172-2183.

CHAPTER 2

Plant clipping decelerates the mineralization of recalcitrant soil organic matter under multiple grassland species

Note: This article has been accepted in *Soil Biology & Biochemistry*.

***PLANT CLIPPING DECELERATES THE MINERALIZATION
OF RECALCITRANT SOIL ORGANIC MATTER UNDER
MULTIPLE GRASSLAND SPECIES***

Tanvir Shahzad ^{a*}, Claire Chenu ^b, Cédric Repinçay ^c, Christian Mougin ^c, Jean-Luc Ollier ^a,
and Sébastien Fontaine ^a

^a INRA, UR 874 Unité de Recherche sur l'Ecosystème prairial, 234-Avenue du Brézet F-63100 Clermont Ferrand, France.

^b AgroParisTech, UMR 7618 Bioemco, Bâtiment EGER, 78850 Thiverval Grignon, France

^c INRA, UR 251 PESSAC (Physicochimie et écotoxicologie des sols d'agrosystèmes contaminés), Route de Saint-Cyr, 78026 Versailles, France

*Author for correspondence

Tanvir SHAHZAD

Email: hereistanvir@gmail.com

I. Summary

Grazing or mowing is central to the management of grasslands and may alter mineralization of soil organic matter (SOM) and soil carbon (C) stocks. Some studies have shown grazing-induced reductions in total soil respiration suggesting decreases in SOM mineralization. However, it has also been suggested that grazing may increase SOM mineralization, based on observations of increased soluble C, microbial biomass and mineral nitrogen (N) in soil after clipping. No studies to date have directly measured SOM mineralization to determine the effects of grazing on SOM mineralization and the underlying mechanisms. We examined the effect of clipping on soil-derived CO₂ efflux (*R_s*) for six gramineae and one leguminous species typical of temperate grasslands. Continuous ¹³C labeling of monocultures coupled with a new method of directly measuring *R_s* and the rhizosphere priming effect (*RPE* i.e. *R_s* from planted soils *minus* respiration from bare soils) in perennial herbaceous plants was used. For a model species, *Lolium perenne*, the clipping effects on aboveground biomass production, mineral N and soluble C in soil, microbial biomass and microbial community composition were also quantified. We found that clipping decreased the *RPE* and *R_s* (SOM mineralization) within 48 hours for all the studied species. For *Lolium perenne*, this reduced SOM mineralization persisted for one month after clipping. Moreover, clipping reduced the production of aboveground biomass and the total N assimilated by the plants. These changes increased N availability in soil and induced shifts in the soil microbial community structure favoring gram positive bacteria (*i16:0*) over saprophytic fungi (*18:2ω6*). The strong correlation of fungi (*18:2ω6*) with *R_s* across treatments suggests that saprophytic fungi play a key role in SOM mineralization. In conclusion, our study shows that plant clipping decelerates SOM mineralization and induces shifts in microbial community structure, most likely as an indirect effect of clipping on plant N uptake.

Keywords:

Priming effect, grazing, soil respiration, ^{13}C labeling, PLFA, temperate grassland, microbial community composition.

II. Introduction

Grassland ecosystems contain almost 12% of earth's organic matter (Schlesinger 1977), 90% of which is estimated to be concentrated belowground in the form of roots and soil organic matter (SOM) (Parton et al., 1993). Grasslands are considered potential carbon (C) sinks in the context of increasing CO₂ levels in the atmosphere provided that they are properly managed (Lal et al., 2007; Li et al., 2008). Managed grasslands cover about 20% of the global terrestrial ice-free surface. Grazing or mowing is central to their management and has been reported to modify plant-litter decomposition (Bardgett et al., 1998; Reeder and Schuman 2002; Klumpp et al., 2009), nutrient cycling (Bardgett et al., 1998; Mikola and Kytoviita 2002) and biodiversity of plants (Collins et al., 1998; Ward et al., 2007) and soil decomposers (Bardgett et al., 2001).

There is disagreement on how plant tissue removal via grazing (or any practice analogous to it like clipping, mowing or defoliation) modifies soil C stocks and fluxes. For example, it has been reported that mowing reduces total soil CO₂ efflux (CO₂ as a result of root respiration and mineralization of plant litter and recalcitrant SOM) by 20-50% despite mowing-induced increases in soil temperature (Bremer et al., 1998; Wan and Luo 2003; Bahn et al., 2006). It has been suggested that this decrease in CO₂ efflux is due to decreased canopy photosynthesis and reduced C supply from aboveground plant parts to roots, mycorrhizae and rhizosphere microorganisms (Bremer et al., 1998; Craine et al., 1999; Bahn et al., 2006). On the other hand, it has been shown that mowing/defoliation can result in increased soluble C, microbial biomass and nitrogen availability in soil (Hamilton and Frank 2001; Henry et al., 2008). Based on these results, Hamilton and Frank (2001) suggested that grazing triggers plant exudation thereby stimulating microbial mineralization of SOM and liberating mineral nitrogen. Although grazing has been shown to accelerate the mineralization of plant litter (Klumpp et al., 2009), increased microbial biomass and availability of soluble C does not

necessarily imply concurrent increases in mineralization of recalcitrant SOM because different microbial groups are specialized in mineralizing different types of organic substrates. The acceleration in mineralization of recalcitrant SOM should only occur if those microbes that specialize in this process are stimulated in the event of increased labile C availability (Fontaine et al., 2003). Thus, the effect of grazing on the mineralization of recalcitrant SOM remains uncertain.

The supply of fresh energy-rich C to soil (e.g. under living roots) stimulates SOM mineralization and soil-derived CO₂ efflux (*R_s*) (Broadbent 1947; Bingeman et al., 1953; Wu et al., 1993; Cheng et al., 2003)- a process termed the rhizosphere priming effect (*RPE*). As a result, fresh C supply by plants and *RPE* are generally positively linked (Dijkstra and Cheng 2007). For example, increased rates of fresh C inputs in soil by plants exposed to elevated atmospheric CO₂ levels have been shown to accelerate SOM mineralization compared with plant-soil systems under ambient CO₂ (Drake et al., 2011; Phillips et al., 2011). In order to quantify the *RPE* induced by plants, current methods are based on a physical separation of soil and plant compartments during the measurement of respiration fluxes. This separation allows the measurement of CO₂ released from the soil compartment and avoids any plant uptake of soil-originated CO₂ through photosynthesis. As a consequence of this separation, the current method is only applicable to single-stem plant and trees, and the *RPE* induced by perennial herbaceous plants, which produce numerous small-statured tillers, has not yet been quantified. Developing a new method for quantifying the *RPE* under such plants is critical to determine grazing effects on recalcitrant SOM mineralization.

In addition to impacts on microbial biomass, grazing has been shown to cause changes in microbial community composition. For example, an increasing intensity of grazing has been shown to decrease the fungi: bacteria ratio in grasslands (Bardgett et al., 2001; Klumpp et al., 2009). This microbial shift can result in important biogeochemical changes because soil

microbial groups have distinct preferences in terms of organic matter sources (van der Heijden et al., 2008; De Deyn et al., 2008). For example, the decrease in abundance of fungi relative to bacteria due to an intensified grazing regime has been postulated to cause increased rates of nutrient cycling and decreased retention of C and N in the litter pool (Bardgett et al., 2005). However, this decrease in fungal abundance could decelerate SOM mineralization since fungi have been identified as actors of the priming effect in soil incubation studies (Fontaine et al., 2011). Linking grazing-induced changes in SOM mineralization with microbial community composition could verify the key role of fungi in SOM mineralization in a real plant-soil system.

Here we use *Lolium perenne* as a model species to test if plant clipping causes any change in soil-derived CO₂ efflux (i.e. SOM mineralization) in the short term (within 48 hours) and in the longer term (after one month). Continuous ¹³C labelling of plants was used to distinguish soil-derived (*R_s*) and plant-derived respiration (*R_p*). The rhizosphere priming effect was calculated as the difference between *R_s* from planted soils and from control bare soil. As the separation of soil and plant compartments is not possible for perennial herbaceous plants, we developed a new method for quantifying the *RPE* that avoids any plant uptake of soil-originated CO₂ through photosynthesis. To stop photosynthesis, plants were placed in sealed respiration chambers in the absence of light during respiration measurements. Phospholipid-fatty-acid (PLFA) analyses were used to determine changes in microbial community composition induced by clipping. The possible generalization of clipping effects on SOM mineralization was tested for six gramineae and one legume species common to temperate grasslands. This study focuses on the short-term effects of grazing-induced changes in plant physiology on SOM mineralization. The effects of modified plant community composition and soil processes after years of grazing management (Ward et al., 2007) is outside of the scope of the present work.

III. Materials & Methods:

III.1. Soil sampling and plant sowing

The soil used in this experiment was sampled from an upland grassland located in the environmental research observatory (SOERE) established by the French National Institute for Agricultural Research (INRA) in central France in 2003 (Theix, 45°43'N, 03°01'E). The local climate is semi-continental, with a mean annual temperature of 9°C and an average annual rainfall of 760mm. Prior to 2003; the site was managed as permanent grassland for more than 50 years (Fontaine et al., 2007). The soil is a drained Cambisol developed from granitic rock. For sampling, the upper 10 cm of the soil profile was removed because it is rich in fresh C. Given that respiration of this pre-existing fresh C cannot be separated from that of recalcitrant soil carbon and that the presence of plants can also modify fresh C decomposition (Personeni and Loiseau 2004), it is advisable to use a soil with a lower proportion of fresh C in order to determine the effects of plants on recalcitrant SOM. Thus, soil was taken from 10-40 cm soil profile. The fresh soil was sieved at 5 mm and used to fill PVC pots (40 cm high, 9.8 cm internal diameter, content 2.87 kg of dry soil). The soil properties were: pH 6.1 ± 0.21 ; clay (%) 27 ± 1.3 ; soil organic carbon (g kg^{-1} soil) 26.7 ± 0.37 and soil organic carbon $\delta^{13}\text{C}$ (‰) - 26.7 ± 0.02 . In April 2009, eight pots were sown with *Lolium perenne* (Lp) at a density of 2000 seeds m^{-2} and four pots were kept bare as control soil (S). Automated drip irrigation methods were used for water supply and all pots were water-saturated whenever the soil moisture decreased to $75 \pm 5\%$ of the soil field capacity. For better handling of the plants in the mesocosm, plants were clipped (non-experimental clipping) 122 days after germination.

After non-experimental clipping, all planted pots were fertilized with nitrogen (NH_4NO_3 , 70 kg N ha^{-1}), phosphorus (KH_2PO_4 , 100 kg P_2O_5 ha^{-1}) and potassium (KNO_3 , 200 kg K_2O ha^{-1}). The control soils (S) were not fertilized. Plants were allowed to fully develop their root system during 190 days before the experimental clipping was administered. Four

planted pots were clipped 5 cm above the soil surface (clipped treatment, CP). Four planted pots were left intact as an unclipped plant control (P). Carbon dioxide and its isotopic composition released by the plant-soil system were measured for all treatments (S, P and CP) immediately and 30 days after experimental clipping. The effect of clipping on SOM mineralization was determined by comparing respiration from P and CP. Plant biomass, plant C and N content, soluble soil organic C, mineral nitrogen, microbial biomass and PLFA were measured following destructive harvesting of pots 30 days after clipping.

To determine whether clipping has similar effect on SOM mineralization across grassland, monocultures of six species namely *Trisetum flavescens* (Tf), *Poa trivialis* (Pt), *Festuca arundinacea* (Fa), *Bromus erectus* (Be), *Brachypodium pinnatum* (Bp) and *Trifolium repens* (Tr) were also established. These species were sown and cultivated in exactly the same conditions as the model species *Lolium perenne*. However, the effect of clipping on SOM mineralization was determined by measuring soil respiration in the same pot before and 24 hours after plant clipping. This approach was adopted to reduce the variation.

III.2. Labelling system & mesocosm

The experimental set-up used is shown in figure 1 (Supplementary information). It consisted of two parts: a labelled-air production system and a mesocosm containing planted and bare-soil pots. Details on production of labeled air are available in Supplementary Information. Briefly, ambient air was taken into the system by a compressor and scrubbed by a molecular sieve, removing CO₂, H₂O and all other particles. The decarbonised air was then mixed with ¹³C-depleted CO₂ of fossil-fuel origin ($\delta^{13}\text{C}$: $-38.55 \pm 0.07 \text{ ‰}$) and passed through a humidifier (1m³:1m² cross corrugated cellulose pads). The water flow in the humidifier was regulated such that the relative humidity of labeled air reaching the mesocosm was maintained around 50-60%. This moistened air had a CO₂ concentration of $400 \pm 20 \text{ ppm}$ before entering the mesocosm.

The mesocosm comprised an iron box with a plexiglass screen mounted on it (mesocosm dimensions: 350 × 140 × 140 cm). The advantage of using plexiglass is that it does not change the wavelength of sunlight entering the mesocosm. All planted and bare-soil pots were placed in mesocosm, and continuously ventilated with air produced by the labeling system. The volume of air in the mesocosm was renewed twice a minute so that the unlabelled air respired by soil would not change the labeling signature of air present in the mesocosm. We verified with a smoke apparatus that turbulences in the mesocosm were sufficient to ensure complete mixing of air. The ventilation of the mesocosm also maintained a temperature difference of 1-2°C between the inside and the outside of the mesocosm.

III.3. Respiration measurement

All pots with plants were put back in the mesocosm for 24 hours after clipping to permit the clipping treatment to take effect on the soil processes through changes in plant photosynthetic and transpiration rates. Pots were then taken out of the mesocosm and sealed in air-tight PVC chambers (height 100 cm, diameter 15 cm) for 24 hrs. The absence of light stopped photosynthesis and stopped the plant absorption of soil-respired CO₂. Carbon dioxide released by the plant-soil system was trapped in 200 ml of 1M NaOH, soda lime traps placed in the respiration chambers. By conducting additional measurements in the respiration chambers using gas chromatography, we established that more than 99% of the CO₂ respired by the pot (soil + plant) over 24 hours was trapped successfully in the NaOH solution. Total carbon trapped in NaOH was measured with a total inorganic-C analyzer. The ¹³C abundance of trapped CO₂ was analyzed with an Isotope-Ratio Mass Spectrometer (IRMS) after precipitating the carbonates with excess BaCl₂ and filtration. The soil-derived CO₂-C (*R_s*, mg CO₂-C kg⁻¹ dry soil day⁻¹) was separated from plant-derived CO₂-C (*R_p*, mg CO₂-C kg⁻¹ dry soil day⁻¹) using mass balance equations:

$$Rs + Rp = Rt$$

$$Rs \times A_s^{13} + Rp \times A_p^{13} = Rt \times A_t^{13}$$

where A_s^{13} is the ^{13}C abundance (dimensionless) of soil carbon, A_p^{13} the ^{13}C abundance of plant, Rt the total CO_2 emitted by the pot (soil *plus* plant) and A_t^{13} its ^{13}C abundance. Rp corresponds to $\text{CO}_2\text{-C}$ coming out from whole plant respiration, mycorrhizae and microbial respiration of rhizodeposits and plant litter.

The rhizosphere priming effect (RPE , $\text{mg CO}_2\text{-C kg}^{-1}$ dry soil day^{-1}) induced by plants was calculated as:

$$RPE = (Rs, \text{planted soil}) - (Rs, \text{control soil})$$

III.4. Soil and plant analyses

Plant roots were washed to remove soil attached to them. Roots and shoots were then dried for 48h at 60°C and finely ground. Dried plant material was analyzed with an elemental analyzer attached to an Isotope-Ratio Mass Spectrometer (IRMS) for total C and N content and ^{13}C abundance. In order to quantify soil mineral nitrogen, 10 g fresh soil was extracted with 40 ml of 1M KCl for 45 minutes. The extract was filtered and analyzed by continuous flow colorimetry. Microbial biomass and the microbial C/N ratio were measured by the fumigation-extraction technique (Vance *et al.*, 1987). The extraction of soluble C with K_2SO_4 (30mM) from soil before the fumigation was used to determine soluble organic carbon in soil.

III.5. PLFA measurements

At the end of the experiment, soil from each pot was removed and a subsample of homogenized soil was sieved at 2 mm to remove remaining plant materials before freeze-drying. Phospholipidic fatty acids (PLFAs) were extracted using a modified method of Bligh and Dyer (1959) (Frostegård *et al.* 1991). Briefly, fatty acids were extracted in a single-phase mixture of chloroform methanol: citrate buffer (1: 2:0,8, v:v:v, pH 4,0) shaken at 300 rpm for

1H. Phase splitting was obtained by adding equal volume of chloroform and citrate buffer. The organic phase was then submitted to a solid phase extraction on silica gel cartridges (Discovery® DSC-Si SPE Tube bed wt. 500 mg, volume 3 mL, from Supelco). Neutral lipids, glycolipids and PLFAs were eluted by chloroform, acetone and methanol, respectively. Methyl nonadecanoate (fatty acid methyl ester 19: 0) was added as an internal standard and PLFAs were *trans*-methylated under mild alkaline conditions to yield fatty acid methyl esters (FAMES), (Dowling et al., 1986). FAMES were then analysed by GC/MS (4000 GC/MS, Varian) in split-less mode (1µL, injector temperature: 250°C) equipped with a BPX70 column (60 m, 0.25mm i.d., 0.25mm df., SGE), and helium as a carrier gas. The temperature program was 50°C for 5 min, raised to 165°C at 15°C/min, followed by increases of 2°C/min up to 225°C. This temperature was held for 15min. To identify the FAMES, the retention times and the mass spectra were compared with those obtained from standards (Bacterial Acid Methyl Ester (BAME) Mix from Supelco and 11 Hexadecenoic acid (92% cis, 8% trans) from Matreya). Gram positive bacterial PLFAs were i15:0, a15:0, i16:0, i17:0 and gram negative bacterial PLFAs were 17:0cy, 19:0cy & 16:1ω9. Fungal PLFAs were 18:1ω9c, 18:2ω9t and 18:2ω6c. The PLFA 16:1ω5c are often considered to represent the arbuscular mycorrhizal fungi (Olsson et al., 1995; Frostegård et al., 2010) although they can also be found in bacteria (Nichols 1986). However, the high density of plant roots and hence mycorrhizae in the soil studied here, suggests that the PLFA 16:1ω5c was predominantly derived from mycorrhizae (Frostegard et al., 2010). Thus our study considers this lipid as representative of arbuscular mycorrhizal fungi. The PLFAs 14:0, 15:0, 16:0, 17:0, 18:0 and 20:0 were analysed as ‘universal’ groups i.e. may be derived from bacteria as well as fungi.

III.6. Statistical Analyses

For the model species *Lolium perenne*, a repeated-measures ANOVA with post hoc pair-wise comparisons was used to determine the effect of clipping on total respiration (R_t), plant-

derived CO₂ efflux (*R_p*) and the rhizosphere priming effect (*RPE*). Time after clipping was included as a random factor. The clipping treatment effect on shoot and root biomass, N export *via* shoot biomass production, C %, N % and C/N of shoots/roots was determined using a paired t-test (95% CI). One way ANOVA was used to determine the effect of treatments (bare soil, clipped or unclipped plants) on soil microbial biomass, microbial N content and C/N ratios, soluble C in soil and various PLFA contents. Relationships between soil mineral N content, the relative abundance of PLFAs in soil and *RPE* were assessed by regression analysis.

For the experiment involving multiple grassland species, multifactor ANOVA was used to determine treatment effects on all effluxes i.e. *R_t*, *R_p*, *R_s*, and *RPE* (species and clipping as fixed factors). For this experiment, the effect of clipping was determined by measuring respiration fluxes in the same pot before and after plant clipping. Given the average temperature was different before and after clipping ($\Delta T=3^{\circ}\text{C}$), all respiration fluxes were normalized to a common temperature (20 °C). All statistical tests were performed with Statgraphics Plus (Manugistics, USA).

IV. Results

IV.1. Plant biomass and isotopic composition

Plants were successfully labeled with ^{13}C -depleted CO_2 and there was no significant difference between aboveground and belowground isotopic signatures (data not shown). The isotopic signature ($\delta^{13}\text{C}$) of different plants varied between $-55.12 \pm 0.03 \text{‰}$ and $-57.23 \pm 0.07 \text{‰}$. The difference between the $\delta^{13}\text{C}$ of soil and plants was more than -28‰ which is

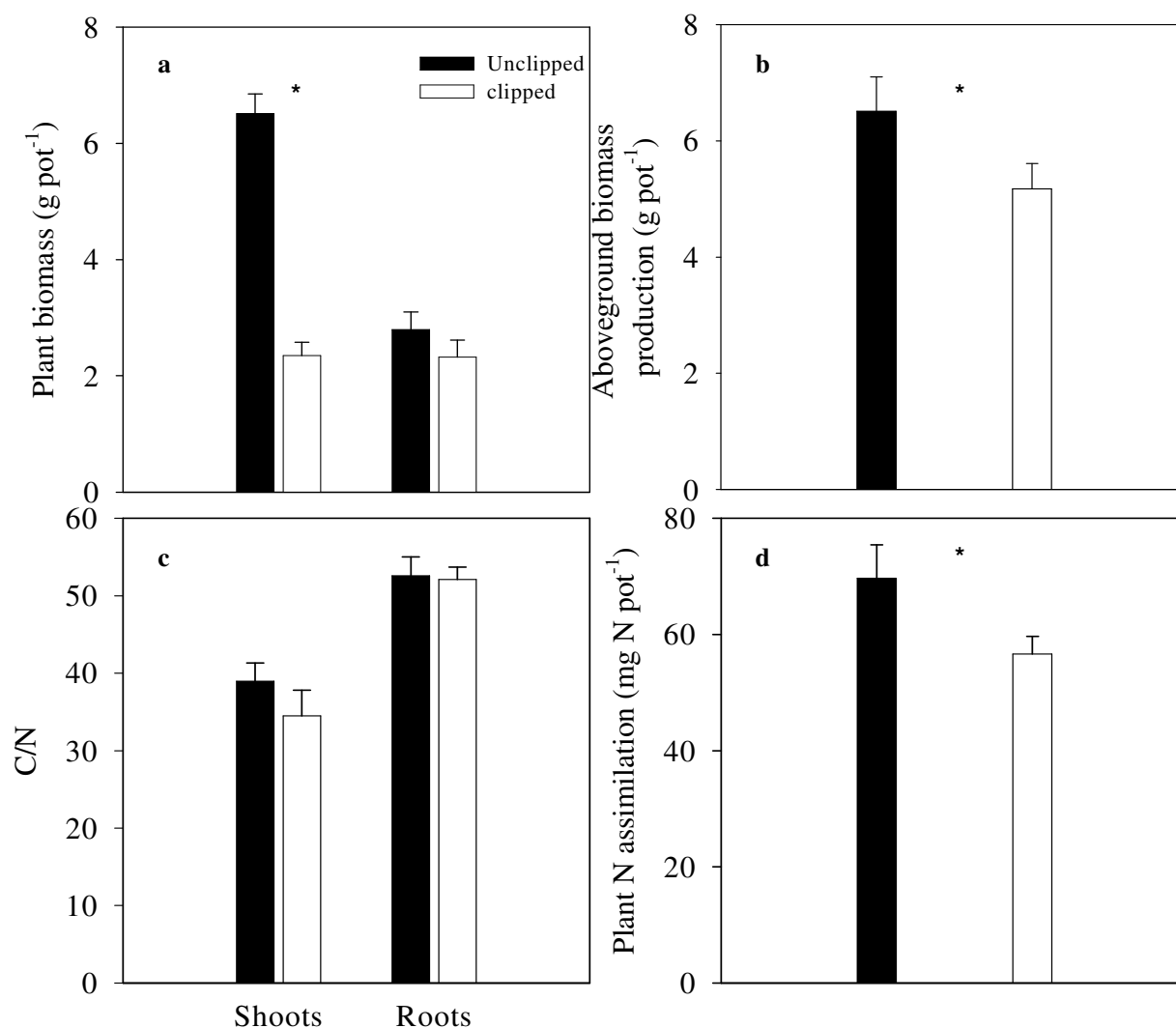

Figure 1. Effects of clipping on plant biomass (a), aboveground biomass production (b), plant C/N ratios (c), and plant N assimilation (d) for *Lolium perenne* (f) (* p -value < 0.05).

sufficient to distinguish plant-derived and soil-derived CO₂ effluxes and to calculate the rhizosphere priming effect.

For the model species, *Lolium perenne*, clipping had no significant effect on root biomass (p -value > 0.05). In contrast, shoot biomass in the clipped treatment was significantly lower than that in the unclipped treatment (p -value < 0.001, Figure 1a). Moreover, when the aboveground biomass harvest of experimental clipping was pooled with that at the end of experiment for the clipped treatment, it was significantly lower than the aboveground biomass of unclipped treatment (p -value < 0.001, Figure 1b). The unclipped treatment showed an increase in aboveground production of 1.34 ± 0.42 g pot⁻¹ compared with the clipped treatment. This corresponded to an increase in N assimilation by plants in the unclipped treatment (13.06 ± 6.48 mg N pot⁻¹; p -value < 0.05, Figure 1d.), given that there was no effect of clipping on the shoot or root C/N ratios (p -value < 0.05, Figure 1c).

IV.2. Respiration fluxes

Clipping caused a rapid (within 48 hours) and significant decrease in total respiration for the model species *Lolium perenne* (p -value < 0.001). This decrease persisted for 30 days after clipping (Table 1). Moreover, this decrease in R_t was a result of significant decreases in both of its components i.e. R_p : the respiration from living plants and microbial respiration of labeled plant rhizodeposits, and R_s : the microbial respiration of SOM.

Irrespective of clipping treatment, the presence of plants significantly accelerated SOM mineralization (R_s) when compared to bare soil (Table 1) indicating a rhizosphere priming effect (RPE). RPE , calculated by subtracting R_s in bare soil from R_s in planted soil, was almost halved (54% of that under unclipped) by clipping and this lower rate of RPE persisted 30 days after clipping for *Lolium* (Table 1, Figure 2a, p -value < 0.001).

In the experiment involving multiple grassland species, clipping was found to significantly reduce the total respiration within 48 hours in all grassland species (p -value <

Table 1: Effects of clipping on different respiration fluxes of the model species *Lolium perenne* and other temperate grassland species. R_t = total CO₂-C, R_p = plant-derived CO₂-C, R_s = soil-derived CO₂-C, RPE = rhizosphere priming effect. Significant differences between clipping treatments are indicated by different letters (p -value < 0.05), values are means (n = 4).

Experiment	Species	Treatment	CO ₂ -C efflux (mg CO ₂ -C kg ⁻¹ soil day ⁻¹)			
			R_t	R_p	R_s	Decrease in RPE due to clipping
<i>Model species</i>	<i>Lolium perenne</i>	<i>1 Day after Clipping</i>				
<u>Experiment</u>		Unclipped	16.93 b	8.84 b	7.7 c	
		Clipped	11.04 a	4.28 a	6.13 b	46 %
		Bare soil			4.27 a	
		<i>30 Days after Clipping</i>				
		Unclipped	13.6 b	6.6 b	7 c	
		Clipped	7.56 a	2.27 a	5.28 b	48 %
		Bare soil			3.44 a	
<i>Generalization</i>	<i>Trisetum</i>	Before clipping	29.44 b	16.62 b	12.82 b	
<u>experiment</u>	<i>flavescens</i>	After clipping	19.47 a	10.66 a	8.82 a	42 %
	<i>Poa trivialis</i>	Before clipping	20.80 b	9.92 b	10.87 b	
		After clipping	14.72 a	5.71 a	9.00 a	20 %
	<i>Festuca</i>	Before clipping	26.64 b	14.11 b	12.53 b	
	<i>arundinacea</i>	After clipping	17.72 a	9.77 a	7.98 a	52 %
	<i>Bromus erectus</i>	Before clipping	24.29 b	12.88 b	11.41 b	
		After clipping	16.24 a	8.03 a	8.21 a	40 %
	<i>Brachypodium</i>	Before clipping	24.25 b	12.15 b	12.10 b	
	<i>pinnatum</i>	After clipping	13.40 a	5.94 a	7.46 a	56 %
	<i>Trifolium repens</i>	Before clipping	112.21 b	85.31 b	26.90 b	
		After clipping	40.86 a	23.64 a	17.22 a	37 %

0.05, Table 1). Again this decrease in R_t was the outcome of significant decreases in both R_s and R_p . Irrespective of clipping treatment, all the grassland species induced a significant acceleration of SOM mineralization i.e. RPE . Clipping caused a significant decrease in RPE

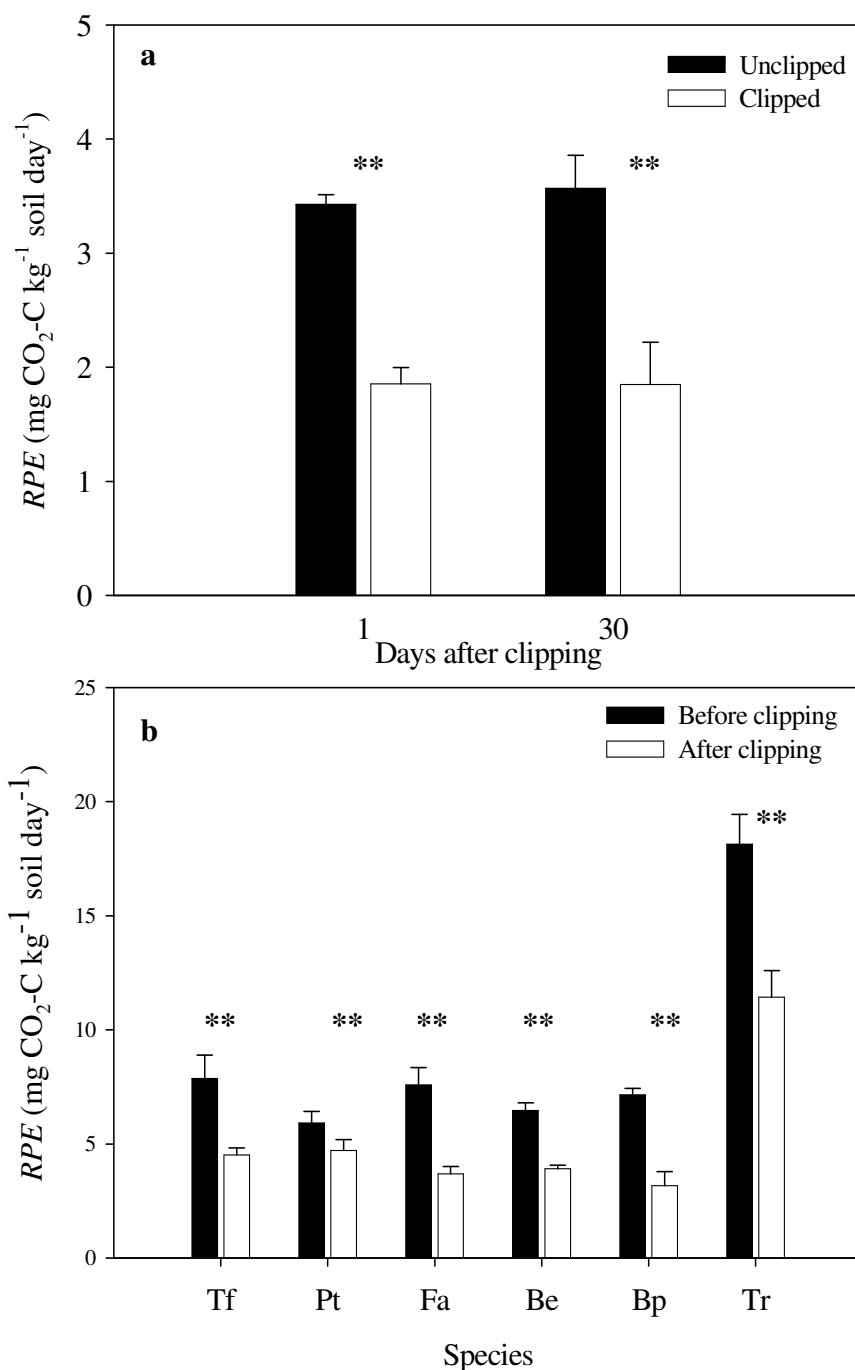

Figure 2. RPE induced in unclipped and clipped treatments 1 and 30 days after clipping for *Lolium perenne* (a), and the RPE before and after clipping across multiple grassland species (***) p -value < 0.001). Tf *Trisetum flavescens*, Pt *Poa trivialis*, Fa *Festuca arundinacea*, Be *Bromus erectus*, Bp *Brachypodium pinnatum*, Tr *Trifolium repens*.

in all the grassland species (p -value < 0.001, Figure 2 b). However the magnitude of clipping-induced decreases in *RPE* varied significantly between species. The minimum decrease was shown by *Poa trivialis* (-20 %) and the maximum decrease occurred in *Brachypodium pinnatum* (-56 %).

IV.3. Soluble C & mineral nitrogen in soil

The organic soluble C in soil increased significantly in the presence of plants (p -value < 0.05, Figure 3a). However, it was not modified by plant clipping.

All the mineral nitrogen present in soils was in the form of nitrate. Mineral nitrogen contents in soil were significantly higher in the clipped compared with the unclipped treatment (Figure 3b). Bare soil pots showed a significantly higher mineral N content compared to treatments with plants. A significant negative correlation was found between the soil mineral N content and the *RPE* induced by plants across clipped and unclipped plant treatments (Figure 4b).

IV.4. Microbial biomass & community composition

The microbial biomass showed a significant increase in the presence of plants (p -value < 0.05, Figure 3c). However, clipping did not modify the microbial biomass (p -value > 0.05, Figure 3c). The C/N ratio of microbial biomass did not show any significant effect of presence of plants or plant clipping (Figure 3d). The mean relative contribution of a saprophytic fungal group (*18:2 ω 6c*) to total PLFA increased significantly in the presence of plants. Moreover, the relative abundance of this fungal group was significantly lower in the clipped treatment compared with the unclipped treatment (p -value < 0.05, Table 2). The mean relative contribution of arbuscular mycorrhizal fungi (AMF, *16:1 ω 5c*) to total PLFA increased in the presence of plants but showed no effect of clipping. A gram positive bacterial group (*i16:0*) was increased by clipping (p -value < 0.05). No other microbial groups showed any effect of clipping or planting.

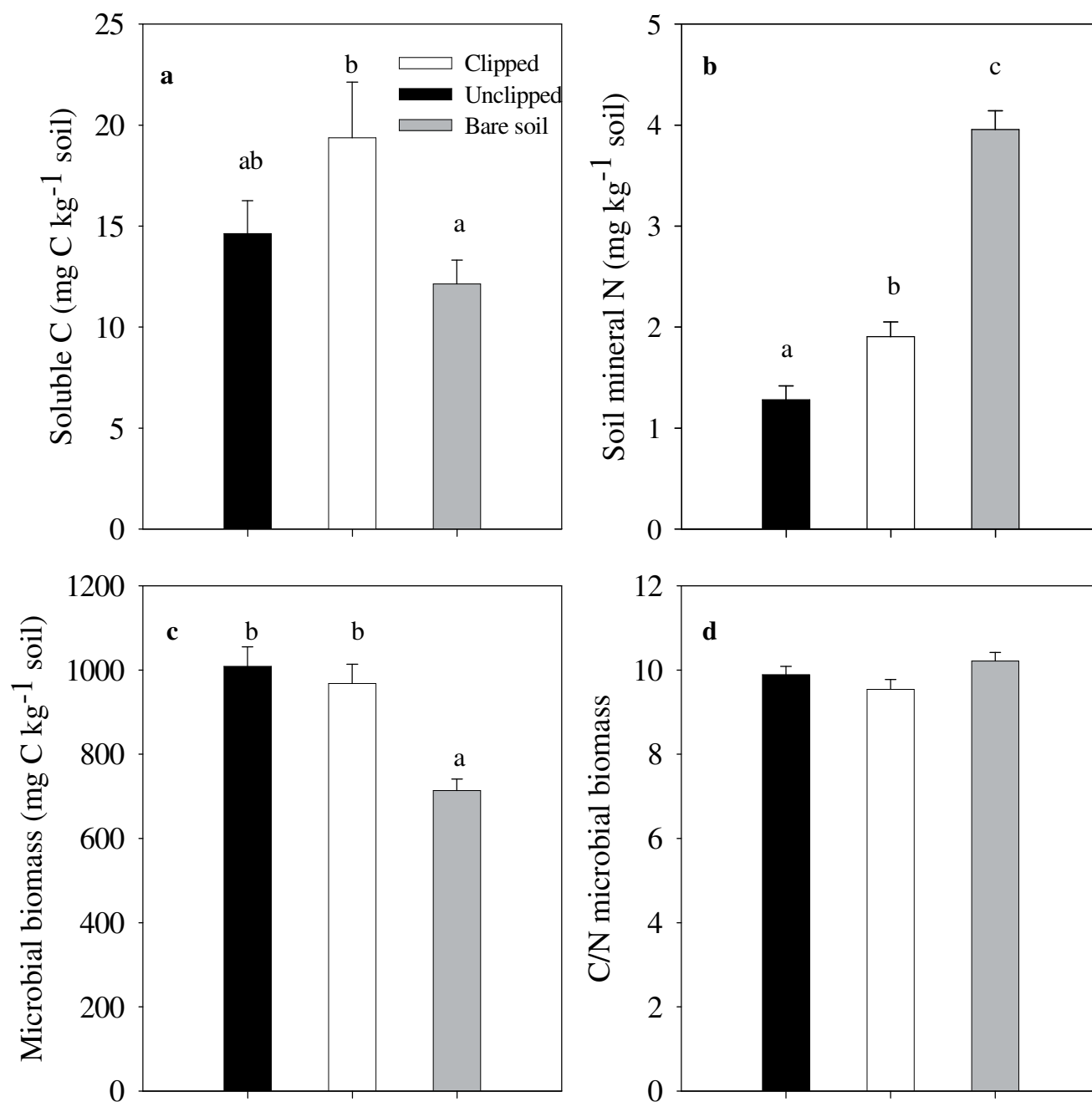

Figure 3. Effects of clipping on microbial biomass (a), soluble C (b), microbial C/N ratio (c) and mineral N (d) for *Lolium perenne* and bare soil treatments (One way ANOVA, p -value < 0.05 when significant).

A significantly positive correlation was found between the relative abundance of saprophytic fungi (i.e. PLFA 18:2 ω 6c) and the R_s across planted and unplanted treatments (Figure 4a). No correlation was found between RPE and the relative abundances of the other

PLFA that varied across clipping treatments (i.e. *16:1 ω 5c* and *i16:0*, data not shown). Moreover, a significant negative correlation was found between the soil mineral N content and the relative abundance of the PLFA *18:2 ω 6c* across clipped and unclipped plant treatments (Figure 4c).

Table 2: Mean relative abundance (mol PLFA C %) of individual biomarker PLFAs in response to experimental treatments (One way ANOVA, p -value < 0.05), NS Non-significant.

Community	PLFA	Bare soil	Un-clipped	Clipped	Change due to clipping (%)
Fungal	<i>18:1ω9t</i>	3.85 ^a	3.38 ^a	3.40 ^a	NS
	<i>18:1ω9c</i>	14.51 ^a	14.04 ^a	12.96 ^a	NS
	<i>18:2ω6c</i>	1.50^a	3.99^c	2.51^b	- 37
AMF	<i>16:1ω5c</i>	2.65^a	3.72^b	3.68^b	NS
Gram (-) Bacteria	<i>17:0cy</i>	7.91 ^a	7.29 ^a	7.36 ^a	NS
	<i>19:0cy</i>	1.64 ^a	1.39 ^a	1.32 ^a	NS
	<i>16:1ω9c</i>	6.55 ^a	5.11 ^a	6.06 ^a	NS
Gram (+) Bacteria	<i>i15:0</i>	6.69 ^a	6.74 ^a	7.57 ^a	NS
	<i>a15:0</i>	7.30 ^a	7.21 ^a	7.78 ^a	NS
	<i>i16:0</i>	7.45^b	6.87^a	7.46^b	8.6
	<i>i17:0</i>	5.35 ^a	5.00 ^a	4.45 ^a	NS
Universal	<i>14:0</i>	0.38 ^a	0.55 ^a	0.55 ^a	NS
	<i>15:0</i>	0.69 ^a	0.80 ^a	0.86 ^a	NS
	<i>16:0</i>	24.91 ^a	26.19 ^a	26.23 ^a	NS
	<i>17:0</i>	1.05 ^a	1.06 ^a	1.08 ^a	NS
	<i>18:0</i>	6.80 ^a	6.01 ^a	6.07 ^a	NS
	<i>20:0</i>	0.77 ^a	0.66 ^a	0.66 ^a	NS

V. Discussion

Using an original method that allowed us to quantify the rhizosphere priming effect induced by grassland species, we show that clipping reduces recalcitrant SOM mineralization and total respiration in the soil-plant system. This result is common to six gramineae and one leguminous species commonly found in temperate grasslands (Figure 2). The decrease in SOM mineralization after plant clipping can explain significant reductions in total soil respiration from ecosystems exposed to clipping and grazing (Bremer et al., 1998; Craine et al., 1999, Wan & Luo, 2003; Cao et al., 2004; Bahn et al., 2006) despite increases in plant litter decomposition (Klumpp et al., 2009). Hamilton & Frank (2001) suggested an increased SOM mineralization after clipping based on increased microbial biomass, soluble C and soil mineral N in their study. They suggested that the increased mineral N after clipping was released from increased SOM mineralization. In agreement with Hamilton & Frank (2001), we found increased soil mineral N following clipping. However, our results do not support the idea that clipping accelerates SOM mineralization. Thus our findings reconcile the apparent contradiction between the results of experiments measuring gas emissions which suggest a decrease in SOM mineralization after clipping (e.g. Bahn et al., 2006) and the results of the experiments measuring soluble C, microbial biomass and mineral N in soil which suggest an increase in SOM mineralization after clipping (e.g. Hamilton and Frank., 2001).

The presence of plants stimulated both the abundance of mycorrhizal and saprophytic fungi and the *RPE* (Table 2). Moreover, clipping induced a strong decrease in the *RPE* (SOM mineralization) and reduced the abundance of specific fungal biomarkers (*18:2 ω 6c*) with no effect on mycorrhizae. Overall, SOM mineralization was significantly correlated with the abundance of saprophytic fungi (PLFA *18:2 ω 6c*, Figure 4a). These results support the idea that fungi play a key role in recalcitrant SOM mineralization and the *RPE* (Fontaine et al., 2011). Moreover, clipping increased the abundance of gram positive bacteria in agreement

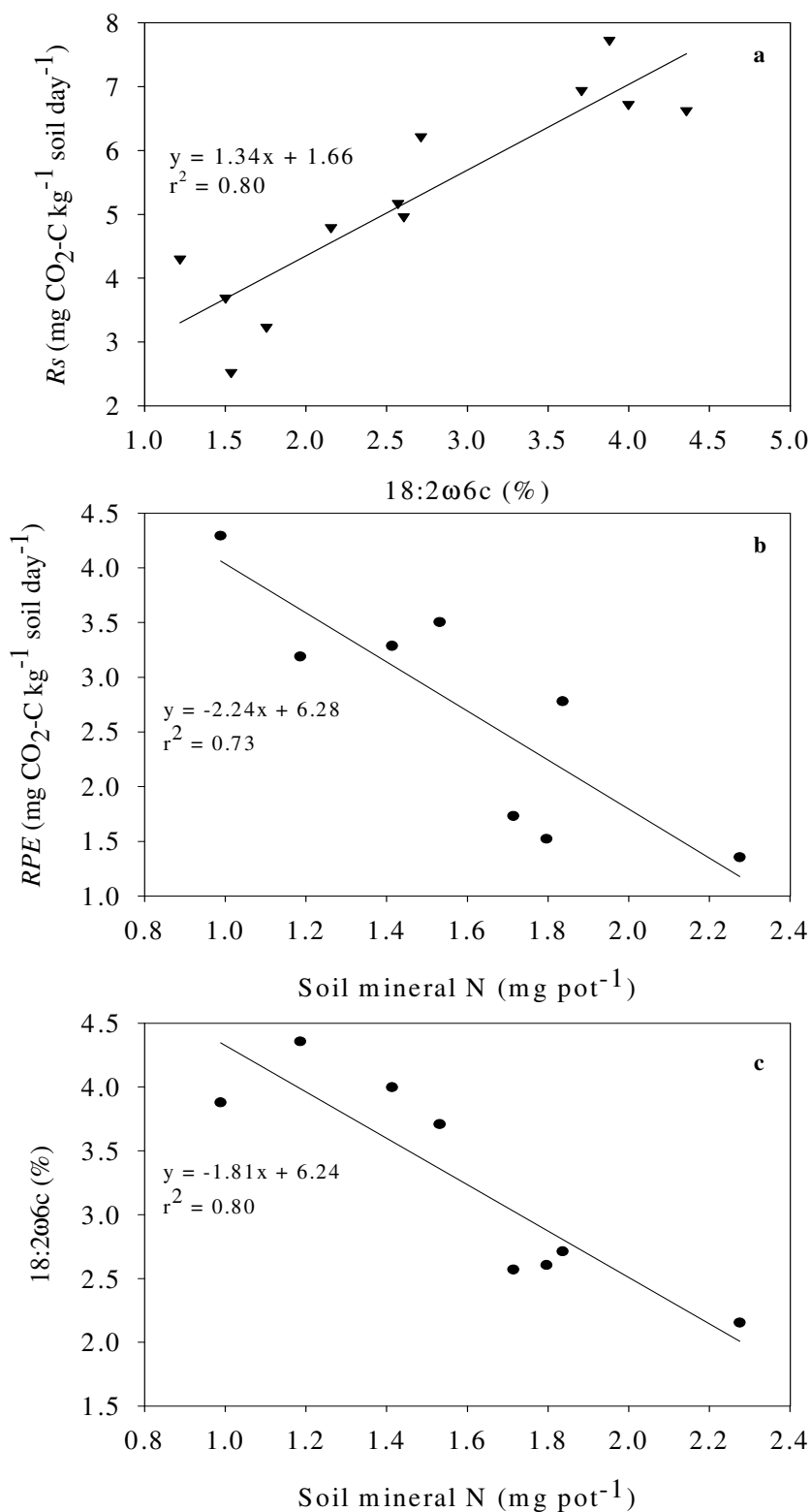

Figure 4. Relationships between the relative abundance of the PLFA 18:2ω6c (%) and R_s (mg CO₂-C kg⁻¹ soil day⁻¹) across planted and unplanted treatments (a) and between RPE (mg CO₂-C kg⁻¹ soil day⁻¹), and the availability of mineral N in soil (b) and between the relative abundance of the PLFA 18:2ω6c (%) and the availability of mineral N in soil across unclipped and clipped *Lolium perenne*.

with other studies (Bardgett et al., 2001; Klumpp et al., 2009). Previous work has shown that the proliferation of gram positive bacteria after clipping induces an acceleration of plant litter decomposition (Klumpp et al., 2009). Our results combined with those of Bardgett et al., (2001) and Klumpp et al. (2009) suggest that clipping modifies the competition between saprophytic fungi and gram positive bacteria for plant C and favors the preservation of recalcitrant SOM.

What are the underlying mechanisms for the clipping-induced decrease in the *RPE* and changes in microbial community structure observed in the model species *Lolium perenne*? Our results suggest that clipping induces a cascade of effects on plant functioning, soil processes and the microbial community. Clipping reduced the production of aboveground biomass and plant N assimilation (Figure 1). This is consistent with the reduced leaf area after clipping which in turn curtails total plant photosynthesis, transpiration and thereby uptake of mineral nitrogen (Macduff 1992). The reduced N uptake by plants led to an increase in mineral N availability (Fig 1) for the soil microbial community. The higher availability of mineral N strongly reduced the priming effect as shown by the negative correlation between the mineral N and *RPE* (Figure 4b). This result supports the results of previous studies carried out in the absence of plants (Fontaine et al., 2004; 2011). The higher availability of N reduces the *RPE* presumably due to two reasons. First, SOM decomposers i.e. fungi could reduce their mining of nutrients in SOM and hence the *RPE*, when availability of mineral N is high (Fontaine et al., 2011). Second, increased availability of mineral N could favor bacteria over fungi in the competition for fresh C acquisition (Bardgett and McAlister 1999). The concomitant decrease in the abundance of the key players in *RPE* i.e. saprophytic fungi, which is negatively linked with mineral N availability (Figure 4c), and the increase in the abundance of gram positive bacteria supports the second idea.

Clipping reduced the *RPE* induced by all seven grassland species studied in our experiment (Figure 2b). However, different species varied in terms of their quantitative response to clipping (Table 1). Interspecific differences in rates of photosynthesis and plant N uptake could underlie the variation in *RPE* responses observed. Therefore, we encourage further research to quantify the impact of clipping on plant N uptake, soil N availability and microbial community structure under various plant species.

Overall, our study shows a strong link between aboveground biomass, plant N uptake and SOM mineralization, suggesting synchrony between plant photosynthesis and soil N availability in grasslands. When plants with high biomass have high photosynthetic rates in favorable conditions (e.g. summer), plant N demand may exceed the soil N offer resulting in decreased soil N availability and increased fungi: bacteria ratios. These changes accelerate SOM mineralization which could liberate N from SOM, stabilizing soil N availability. Alternatively, when plant photosynthesis is reduced due to clipping or low light intensity, plant N uptake may be lower than the soil N offer. The accumulation of mineral N in soil decreases SOM mineralization, which could lead to sequestration of mineral N in SOM. Unless this excess in nutrients is sequestered in the soil, nutrient loss will occur via leaching or denitrification. Management of such synchrony between plant photosynthesis and soil N availability may maximize plant productivity, nutrient retention and thereby C sequestration in grasslands. Future studies are required to verify the existence of the link between SOM mineralization and the consequent release of mineral nitrogen from SOM.

Acknowledgement

We thank S. Revaillet and O. Delfosse for chemical and isotopic analyses. Maurice Crocombette and Patrick Pichon are thanked for their valuable help in mesocosm construction and experiment establishment respectively. The research received funding from the European Community's 6th and 7th Framework Programs (FP6 and FP7) under grant agreement n°

017841 (Nitro-Europe) and n° 226701 (CARBO-Extreme). The funding from National Research Agency's project BIOMOS is also acknowledged. TS has been funded by Higher Education Commission of Pakistan (HEC) and European Community's 7th framework under grant agreement n° 226701 (CARBO-EXTREME).

VI. References

- Bahn, M., Knapp, M., Garajova, Z., Pfahringer, N., Cernusca, A., 2006. Root respiration in temperate mountain grasslands differing in land use. *Global Change Biology* 12, 995-1006.
- Bardgett, R.D., Bowman, W.D., Kaufmann, R., Schmidt, S.K., 2005. A temporal approach to linking aboveground and belowground ecology. *Trends in Ecology & Evolution* 20, 634-641.
- Bardgett, R.D., Jones, A.C., Jones, D.L., Kemmitt, S.J., Cook, R., Hobbs, P.J., 2001. Soil microbial community patterns related to the history and intensity of grazing in submontane ecosystems. *Soil Biology and Biochemistry* 33, 1653-1664.
- Bardgett, R.D., McAlister, E., 1999. The measurement of soil fungal: bacterial biomass ratios as an indicator of ecosystem self-regulation in temperate meadow grasslands. *Biology and Fertility of Soils* 29, 282-290.
- Bardgett, R.D., Wardle, D.A., Yeates, G.W., 1998. Linking above-ground and below-ground interactions: how plant responses to foliar herbivory influence soil organisms. *Soil Biology and Biochemistry* 30, 1867-1878.
- Bingeman, C.W., Varner, J.E., Martin, W.P., 1953. The effect of the addition of organic materials on the decomposition of an organic soil. *Soil Science Society of America Journal*. 17, 34-38.
- Bligh, E.G., Dyer, W.J., 1959. A rapid method of total lipid extraction and purification. *Canadian Journal of Biochemistry and Physiology* 37, 911-917.
- Bremer, D.J., Ham, J.M., Owensby, C.E., Knapp, A.K., 1998. Responses of soil respiration to clipping and grazing in a tallgrass prairie. *Journal of Environmental Quality* 27, 1539-1548.

- Broadbent, 1947 F.E. Broadbent, Nitrogen release and carbon loss from soil organic matter during decomposition of added plant residues. *Soil Science Society of America Proceedings*, **12** (1947), pp. 246–249.
- Cao, G., Tang, Y., Mo, W., Wang, Y., Li, Y., Zhao, X., 2004. Grazing intensity alters soil respiration in an alpine meadow on the Tibetan plateau. *Soil Biology and Biochemistry* **36**, 237-243.
- Cheng, W., Johnson, D.W., Fu, S., 2003. Rhizosphere effects on decomposition: controls of plant species, phenology, and fertilization. *Soil Science Society American Journal*. **67**, 1418-1427.
- Collins, S.L., Knapp, A.K., Briggs, J.M., Blair, J.M., Steinauer, E.M., 1998. Modulation of Diversity by Grazing and Mowing in Native Tallgrass Prairie. *Science* **280**, 745-747.
- Craine, J., Wedin, D., Chapin, F., 1999. Predominance of ecophysiological controls on soil CO₂ flux in a Minnesota grassland. *Plant and Soil* **207**, 77-86.
- De Deyn, G.B., Cornelissen, J.H.C., Bardgett, R.D., 2008. Plant functional traits and soil carbon sequestration in contrasting biomes. *Ecology Letters* **11**, 516-531.
- Dijkstra, F.A., Cheng, W., 2007. Interactions between soil and tree roots accelerate long-term soil carbon decomposition. *Ecology Letters* **10**, 1046-1053.
- Dowling, N.J.E., Widdel, F., White, D.C., 1986. Phospholipid ester-linked fatty acid biomarkers of acetate-oxidizing sulphate-reducers and other sulphide-forming bacteria. *Journal of General Microbiology* **132**, 1815-1825.
- Drake, J.E., Gallet-Budynek, A., Hofmockel, K.S., Bernhardt, E.S., Billings, S.A., Jackson, R.B., Johnsen, K.S., Lichter, J., McCarthy, H.R., McCormack, M.L., Moore, D.J.P., Oren, R., Palmroth, S., Phillips, R.P., Pippen, J.S., Pritchard, S.G., Treseder, K.K., Schlesinger, W.H., DeLucia, E.H., Finzi, A.C., 2011. Increases in the flux of carbon

- belowground stimulate nitrogen uptake and sustain the long-term enhancement of forest productivity under elevated CO₂. *Ecology Letters* 14, 349-357.
- Fontaine, S., Bardoux, G., Abbadie, L., Mariotti, A., 2004. Carbon input to soil may decrease soil carbon content. *Ecology Letters* 7, 314-320.
- Fontaine, S., Barot, S., 2005. Size and functional diversity of microbe populations control plant persistence and long-term soil carbon accumulation. *Ecology Letters* 8, 1075-1087.
- Fontaine, S., Barot, S., Barre, P., Bdioui, N., Mary, B., Rumpel, C., 2007. Stability of organic carbon in deep soil layers controlled by fresh carbon supply. *Nature* 450, 277-280.
- Fontaine, S., Henault, C., Aamor, A., Bdioui, N., Bloor, J.M.G., Maire, V., Mary, B., Revaillo, S., Maron, P.A., 2011. Fungi mediate long term sequestration of carbon and nitrogen in soil through their priming effect. *Soil Biology and Biochemistry* 43, 86-96.
- Fontaine, S., Mariotti, A., Abbadie, L., 2003. The priming effect of organic matter: a question of microbial competition? *Soil Biology and Biochemistry* 35, 837-843.
- Frostegard, A., Tunlid, A., Baath, E., 1991. Microbial biomass measured as total lipid phosphate in soils of different organic content. *Journal of Microbiological Methods* 14, 151-163.
- Frostegard, A., Tunlid, A., Bâath, E., 2010. Use and misuse of PLFA measurements in soils. *Soil Biology and Biochemistry* 43, 1621-1625.
- Hamilton, E.W., Frank, D.A., 2001. Can plants stimulate soil microbes and their own nutrient supply? Evidence from a grazing tolerant grass. *Ecology* 82, 2397-2402.
- Henry, F., Vestergård, M., Christensen, S., 2008. Evidence for a transient increase of rhizodeposition within one and a half day after a severe defoliation of *Plantago arenaria* grown in soil. *Soil Biology and Biochemistry* 40, 1264-1267.

- Klumpp, K., Fontaine, S., Attard, E., Le Roux, X., Gleixner, G., Soussana, J.-F., 2009. Grazing triggers soil carbon loss by altering plant roots and their control on soil microbial community. *Journal of Ecology* 97, 876-885.
- Lal, R., Follett, F., Stewart, B.A., Kimble, J.M., 2007. Soil carbon sequestration to mitigate climate change and advance food security. *Soil Science* 172, 943-956.
- Li, X.D., Fu, H., Li, X.D., Guo, D., Dong, X.Y., Wan, C.G., 2008. Effects of land-use regimes on carbon sequestration in the Loess Plateau, northern China. *New Zealand Journal of Agricultural Research* 51, 45-52.
- Macduff, J.H., Jackson, S.B., 1992. Influx and efflux of nitrate and ammonium in Italian ryegrass and white clover roots - comparisons between effects of darkness and defoliation. *Journal of Experimental Botany* 43, 525-535.
- Mikola, J., Kytöviita, M.-M., 2002. Defoliation and the availability of currently assimilated carbon in the *Phleum pratense* rhizosphere. *Soil Biology and Biochemistry* 34, 1869-1874.
- Nichols, P., Stulp, B.K., Jones, J.G., White, D.C., 1986. Comparison of fatty acid content and DNA homology of the filamentous gliding bacteria *Vitreoscilla*, *Flexibacter*, *Filibacter*. *Archives of Microbiology* 146, 1-6.
- Olsson, P.I.A., Bååth, E., Jakobsen, I., Söderström, B., 1995. The use of phospholipid and neutral lipid fatty acids to estimate biomass of arbuscular mycorrhizal fungi in soil. *Mycological Research* 99, 623-629.
- Parton, W.J., Scurlock, J.M.O., Ojima, D.S., Gilmanov, T.G., Scholes, R.J., Schimel, D.S., Kirchner, T., Menaut, J.C., Seastedt, T., Moya, E.G., Kamnalrut, A., Kinyamario, J.I., 1993. Observations and modeling of biomass and soil organic-matter dynamics for the grassland biome worldwide. *Global Biogeochemical Cycles* 7, 785-809.

- Personeni, E., Loiseau, P., 2004. How does the nature of living and dead roots affect the residence time of carbon in the root litter continuum? *Plant and Soil* 267, 129-141.
- Phillips, R.P., Finzi, A.C., Bernhardt, E.S., 2011. Enhanced root exudation induces microbial feedbacks to N cycling in a pine forest under long-term CO₂ fumigation. *Ecology Letters* 14, 187-194.
- Reeder, J.D., Schuman, G.E., 2002. Influence of livestock grazing on C sequestration in semi-arid mixed-grass and short-grass rangelands. *Environmental Pollution* 116, 457-463.
- Schlesinger, W.H., 1977. Carbon balance in terrestrial detritus. *Annual Review of Ecology and Systematics* 8, 51-81.
- Van Der Heijden, M.G.A., Bardgett, R.D., Van Straalen, N.M., 2008. The unseen majority: soil microbes as drivers of plant diversity and productivity in terrestrial ecosystems. *Ecology Letters* 11, 296-310.
- Vance, E.D., Brookes, P.C., Jenkinson, D.S., 1987. An extraction method for measuring soil microbial biomass-C. *Soil Biology & Biochemistry* 19, 703-707.
- Wan, S.Q., Luo, Y., 2003. Substrate regulation of soil respiration in a tallgrass prairie: results of a clipping and shading experiment. *Global Biogeochemical Cycles* 17, 1054.
- Ward, S., Bardgett, R., McNamara, N., Adamson, J., Ostle, N., 2007. Long-term consequences of grazing and burning on northern peatland carbon dynamics. *Ecosystems* 10, 1069-1083.
- Wu, J., Brookes, P.C., Jenkinson, D.S., 1993. Formation and destruction of microbial biomass during the decomposition of glucose and ryegrass in soil. *Soil Biology & Biochemistry* 25, 1435-1441.

CHAPTER 3

**Living roots induce the mineralization of 15, 000 years old organic
C from deep soil of a temperate grassland**

***LIVING ROOTS INDUCE THE MINERALIZATION OF 15, 000
YEARS OLD ORGANIC C FROM DEEP SOIL OF A
TEMPERATE GRASSLAND***

Tanvir SHAHZAD^{a*}, Claire Chenu^b and Sébastien FONTAINE^a

^a INRA, UR 874 Unité Recherche d'Ecosystème prairial, 234-Avenue du Brézet 63100
Clermont Ferrand, France.

^b AgroParisTech, UMR BIOEMCO (*Biogéochimie et Ecologie des Milieux Continentaux*)
AgroParisTech Grignon, 78850 Thiverval Grignon, France

*Author for correspondence

Tanvir SHAHZAD

Email: hereistanvir@gmail.com

Telephone: +33 981 468 197

Fax: +33 473 62 44 57

I. Summary

The main focus of studies concerning dynamics of soil carbon has been the first 20 cm of soil. However, it has been shown that more than fifty percent of soil C (relative to 1m depth) resides in 20-100 cm of soil depth for centuries to millennia. The fate of this ancient deep soil C will be crucial under changed climates and associated land use changes. However, the mechanisms controlling the stability of deep soil C remain unclear. We demonstrate that rhizodeposition in deep soil layers by a deep-rooted grassland plant, *Festuca arundinaceae*, induced the microbial mineralization of about 15,000 years old deep soil C. This rhizosphere priming effect was maintained during 511 days of experiment and was strongly correlated with fresh C respired. The soil C mineralization was strongly correlated with a saprophytic fungal biomarker (18:2 ω 6c) suggesting that fungi are key actors in the mineralization of recalcitrant organic C in deep soil. Collectively, these results support the idea that the energy-limitation faced by deep soil microbes due to limited supply of fresh C is the reason for the stability of deep soil C over centuries to millennia. Moreover, the saprophytic fungi represented by 18:2 ω 6c biomarker are suggested to be involved in SOM mineralization and rhizosphere priming effect. The vulnerability of ancient soil C to microbial mineralization after the supply of fresh C supply warrants further research on the proposals of sequestering organic matter in deep soils expecting its long term stabilization there.

Keywords:

Deep soil carbon, rhizosphere priming effect, soil organic matter, ^{14}C dating, ^{13}C labelling, PLFA

II. Introduction

The world soils are largest reservoir of soil organic matter (SOM) containing more carbon (C) than is present either in vegetation or the atmosphere (Jobbàgy and Jackson 2000). The estimates of organic C stocks in 1m depth of world soils range from 1220 Pg (Sombroek et al., 1993) to about 1550 Pg (Batjes 1996; Jobbàgy and Jackson 2000) or even up to 2000 Pg (Janzen 2005). The main focus of the scientists studying the mechanisms of stabilization and mineralization of SOM has remained the 0 to 20 or 30 cm upper soil layer although the percentage of SOM present in 20-100 cm soil depth (relative to first meter of soil) has been estimated as 67%, 58% and 50% for shrublands, grasslands and forests respectively (Jobbàgy and Jackson 2000). The deep soil C was generally neglected because the ^{14}C dating showed that this is thousands of years old suggesting that the deep soil C is inert i.e. chemically recalcitrant or protected by soil minerals (Trumbore 2000). However, the respiration of centuries old C in response to drying-rewetting cycles (Schimel et al., 2011) and millennia old carbon after labile C additions (Fontaine et al., 2007) from deep soil indicates that the deep soil C, or significant part of it, is vulnerable to microbial decomposition. Thus it is important to better understand the mechanisms controlling the stability of deep soil C in order to determine its vulnerability to climate change. The knowledge of these mechanisms could also lead to developing strategies to store C in deep soil layers over long term.

It has been argued that high spatial heterogeneity of SOM and microbial distributions and limited diffusion of soil C to active microbes in deep soil horizons in comparison to surface soil are the possible causes of slow mineralization of deep soil C (Rumpel and Kögel-Knaber 2011). Schimel et al. (2011) showed that the alternating drying and rewetting cycles induced the mineralization of 850 years old C from 1m deep horizon of an annual grassland. They argued that the mass flow of water associated with rewetting overcame the limited diffusion of old C to active microbes and thus promoted its release as CO_2 . Similarly, the

increase in SOM mineralization after disrupting the structure of deep soil (Salomé et al., 2010) supported this theory of spatial heterogeneity between C and microbial communities. In addition of the mechanism of spatial heterogeneity between SOM and microbial biomass, Fontaine et al. (2007) hypothesized that the deep soil microbes are more limited by the availability of energy-rich substrates than their counterparts in surface soil because the rhizodeposition in deep soil layers is many orders less than that in surface soil. The mineralization of humified recalcitrant SOM can only operate in the presence of fresh energy-rich rhizodeposits because the acquisition of energy from SOM is not sufficient to sustain biological activity. This energy-limitation hypothesis was supported by a lab incubation experiment where the supply of cellulose reactivated the mineralization of 2500 years' old organic carbon from deep soil.(Fontaine et al., 2007). The experiment of Fontaine et al., (2007) was a lab incubation where soil structure was disrupted and the substrate was a pure organic compound. To determine if energy-limitation is the reason behind deep soil C stability in ecosystems, it remains to test the vulnerability of deep soil C to rhizodeposition in deep soil layers by deep rooted plants.

It has been shown that the living roots of annual plants, young trees and perennial grasses can accelerate the mineralization of recalcitrant SOM in surface soils by stimulating the soil decomposer community with energy-rich labile C substrates i.e. induce priming effect (Cheng et al., 2003; Dijkstra and Cheng 2007; Chapter 1 of this thesis). Moreover, the increased input of labile C in surface soils can also cause net C loss (Fontaine et al., 2004; Dijkstra and Cheng 2007) and increase gross N mineralization (Dijkstra et al., 2011). The response of deep soil C to the presence of living roots in terms of SOM mineralization, soil C stocks and gross N mineralization can be expected to be similar to that of surface soils given that the living roots could stimulate soil microorganisms with the input of fresh C (labile organic C).

It is not clear yet which microbes or microbial groups are involved in the mineralization of soil organic matter and thus priming effect. The saprophytic fungi have been suggested to mediate priming effect (Fontaine et al., 2011) due to their ability to reach the stabilized SOM as well as labile C through their hyphae. The correlation of a lipidic fungal biomarker (18:2 ω 6c) with priming effect and mineralization of SOM in a lab experiment (Fontaine et al., 2011) and in mesocosm study involving grasses (Chapter 1 of this thesis) supports the idea that the fungi play key role in recalcitrant SOM mineralization. However, some bacterial species have also been shown to contribute to priming effect after the supply of fresh C to soil microbes (Bernard et al., 2007; Nottingham et al., 2009).

This study aims to determine if the stability of deep soil C is due to energy-limitation of deep soil microbes by testing if the supply of rhizodeposits from living plant into deep soil can induce the reactivation of mineralization of ancient SOM. A grassland species, *Festuca arundinacea*, capable of producing deep roots was used to ensure the supply of fresh C in deep soil layers. A continuous dual C labelling (^{13}C & ^{14}C) of *Festuca arundinacea* allowed the separation of plant-derived $\text{CO}_2\text{-C}$ from soil-derived $\text{CO}_2\text{-C}$, calculation of rhizosphere priming effect and ^{14}C dating of soil C released by priming. The consequence of accelerated SOM mineralization for soil N availability was quantified by measuring gross N mineralization and long term net N mineralization. Phospholipids fatty-acid (PLFA) of soil were analysed to determine the microbial groups potentially contributing to SOM mineralization

III. Materials & Methods

III.1. Soil sampling and plant sowing

The soil used in this experiment was sampled from an upland grassland located in the environmental research observatory (ORE) established by the French National Institute for Agricultural Research (INRA) in central France in 2003 (Theix, 45°43'N, 03°01'E). The local climate is semi-continental, with a mean annual temperature of 9°C and an average annual rainfall of 760mm. Before 2003, the site had been under grassland for more than 50 years and was covered with forests of chestnut and hornbeam 2000 years ago (Boivin et al., 2004). The soil is a drained Cambisol developed from granitic rock. In March 2009, eight intact soil cores up to 80 cm deep were taken within 1 m distance to each other. These cores were taken within 2-5 m distance of soil profiled studied by Fontaine et al. (2007). The top 10 cm of each profile was removed for all cores because it was rich in root litter and fresh soil C. Given that the respiration of this pre-existing fresh C cannot be separated from that of old soil carbon and that the presence of plants can also modify fresh C decomposition (Personeni and Loiseau 2004), it is advisable to use a soil with a low proportion of fresh C in order to determine the effect of plants on recalcitrant SOM. The cores were then carefully inserted in PVC tubes (80 cm long, 9.8 cm internal diameter) without disturbing soil structure. On 25 March 2009, four of these pots containing intact soil cores were sown with *Festuca arundinacea* at density of 2000 seeds m⁻² and four were kept bare for comparison with planted ones. Immediately after germination all planted and bare soil pots were placed in a dual labelling (¹³C & ¹⁴C) mesocosm (see chapter 1 of this thesis) for whole duration of experiment (511 days). Plants were fertilized with nitrogen (70 kg N ha⁻¹), phosphorus (100 kg P₂O₅ ha⁻¹) and potassium (200 kg K₂O ha⁻¹) 122 and 364 days after sowing. During first application of fertilizer, sulfur (20 kg S ha⁻¹) and magnesium (60 kg MgO ha⁻¹) were also applied. Before sowing, all pots containing soil cores were immersed in water till the soil cores were water saturated. The

weight of soil pots at field capacity was then determined by weighing them after water percolation from the base of pots stopped. This estimation was used to keep the soil moisture around $75\pm 5\%$ of field capacity of soil using automated drip irrigation method and adjusting the water gravimetrically. The plants were clipped thrice to 5cm from ground 122, 189 and 413 days after sowing.

III.2. Respiration measures

The plant roots grew quickly reaching the base of pots (80 cm soil depth) within three months. The effect of plants presence on mineralization of recalcitrant SOM was determined for the whole profile throughout the experiment. For measuring respiration, the pots were taken out periodically from the labelling mesocosm and were sealed in air-tight PVC chambers (height 100 cm, diameter 15 cm) for 24 hrs. The absence of light stopped photosynthesis and avoided the plant absorption of soil respired CO_2 . Carbon dioxide released by the plant-soil system was trapped in 200 ml of 1M NaOH that was placed in respiration chambers. By conducting additional measurement on respiration chambers by gas chromatography, we quantified that more than 99% of CO_2 respired by the pot (soil + plant) over 24 hours was trapped successfully into NaOH. Total carbon trapped in NaOH was measured with a total inorganic-C analyzer. The ^{13}C abundance of trapped CO_2 was analysed with an Isotope-Ratio Mass Spectrometer (IRMS) after precipitating the carbonates with excess BaCl_2 and filtration. The soil-derived $\text{CO}_2\text{-C}$ (R_s , $\text{mg CO}_2\text{-C kg}^{-1}$ dry soil day^{-1}) was separated from plant-derived $\text{CO}_2\text{-C}$ (R_p , $\text{mg CO}_2\text{-C kg}^{-1}$ dry soil day^{-1}) using mass balance equations:

$$R_s + R_p = R_t$$

$$R_s \times A_s^{13} + R_p \times A_p^{13} = R_t \times A_t^{13}$$

where A_s^{13} is the ^{13}C abundance (dimensionless) of soil carbon, A_p^{13} the ^{13}C abundance of plant, R_t the total CO_2 emitted by the pot (soil *plus* plant) and A_t^{13} its ^{13}C abundance. R_p

corresponds to CO₂-C coming out from whole plant respiration, mycorrhizae and microbial respiration of rhizodeposits and plant litter.

The rhizosphere priming effect (*RPE*, mg CO₂-C kg⁻¹ dry soil day⁻¹) induced by the plant was calculated as:

$$RPE = (R_s, \text{planted soil}) - (R_s, \text{control soil})$$

After 511 days, plants were clipped to base. Afterwards each planted and bare soil pot was cut horizontally into three parts in order to quantify the priming effect induced in different horizons due to rhizodeposits as well as to determine the ¹⁴C age of released soil C. From top to bottom, they represented surface (10-33 cm), middle (33-56 cm) and deep soil (56-80 cm) horizons in field. The soil was maintained within PVC tubes to preserve the soil structure. These soil horizons were placed in respiration chambers for seven days with 200 ml 1.5M NaOH. The fixed C in NaOH was analysed and separated into different components similar to those for whole profile measures.

Then, we calculated the ¹⁴C content (expressed in pMC) of SOC released as CO₂ (A_s^{14}) with the equation

$$R_s \cdot A_s^{14} + R_p \cdot A_p^{14} = R_T \cdot A_T^{14}$$

where A_p^{14} is the ¹⁴C content of plant-derived C and A_T^{14} the ¹⁴C content of the total CO₂ emitted by planted soil. A_s^{14} was converted into age BP using the Libby half-life of ¹⁴C.

The priming effect (*RPE*, mg C-CO₂ kg⁻¹ soil) induced by the addition of labile C from roots was calculated as

$$PE = (R_s \text{ planted soil}) - (R_s \text{ bare soil})$$

We calculated the ¹⁴C content of the pool of SOC decomposed *via* the priming effect (A_{pe}^{14}) as

$$A_{pe}^{14} = \frac{(R_S \text{ planted soil}) \cdot A_S^{14} - (R_S \text{ bare soil}) \cdot A_{S0}^{14}}{PE}$$

where A_{S0}^{14} is the ^{14}C content of CO_2 emitted in the bare soil. A_{pe}^{14} was converted into age BP as previously described.

III.3. Soil carbon fractions

After measuring the respiration for different soil horizons, the soils were harvested and the thoroughly mixed. In order to determine root biomass in each horizon, all visible roots were hand picked and were washed with tap water to remove soil. The soil was then placed at 4-5 °C till they were taken out to determine different organic matter fractions. Free organic matter fractions were separated with by passing the soil through a series of two brass sieves (wet sieving) of decreasing mesh sizes (5 and 1 mm). The remaining material in each sieve was separated into mineral and organic fraction by density flotation in water (Loiseau and Soussana 1999). The >5 mm fraction was named rhizome and was added with root fraction and C content of roots was considered similar to those of rhizome fraction. The >1 mm fraction was considered as particulate organic matter and was oven dried and analysed for their C content. A part of harvested soil was air dried. The soil was sieved at 1mm and finely ground before being analyzed for soil organic carbon (SOC) content. All analyses for carbon content and $\delta^{13}\text{C}$ were with an elemental analyser.

III.4. Soil nitrogen

At the end of experimpent, the pots containing different soil layers were destroyed and soil from each pot was thoroughly homogenised. In order to measure gross N mineralization, 400 μl of $^{15}\text{NH}_4^{15}\text{NO}_3$ (99.8%) solution (concentration 40 mg N L^{-1}) was added to 10 g fresh soil sample that was moistened to soil field capacity. One set of ^{15}N -added soils was extracted, within 15 minutes of ^{15}N addition, with 40 ml of 1M KCl after shaking for 45 minutes as control. The other set of ^{15}N -added soils was incubated in air-sealed incubation glass flasks at

20 °C. After 24 hours, they were extracted for N with 1M KCl after shaking for 45 minutes. A set of replicates of both extracts i.e. control and those incubated for 24 hours, were analysed using continuous flow colorimeter

Net nitrogen mineralization was determined for all soil layers for 79 days. A 10 g fresh soil sample, moistened to field capacity, for each replicate was incubated in air-sealed incubation glass flasks at 20 °C. Four independent sets flasks were prepared in order to measure mineral nitrogen content after 0, 8, 21, 51 and 79 days of incubation. In order to quantify soil mineral nitrogen, the soil was extracted with 40 ml of 1M KCl after shaking for 45 minutes. The extract was filtered and analysed by continuous flow colorimeter.

III.5. PLFA measurements

A 2 g sample from each sample was freeze-dried, sieved at 2 mm and the remaining plant debris were removed. Phospholipidic fatty acids (PLFAs) were extracted using a modified method of Bligh and Dyer (1959) (Frostegård et al., 1991). Briefly, fatty acids were extracted in a single-phase mixture of chloroform: methanol: citrate buffer (1:2:0.8, v/v/v, pH 4.0) shaken at 300 rpm for 1H. Phase splitting was obtained by adding equal volume of chloroform and citrate buffer. The organic phase was then submitted to solid phase extraction on silica gel cartridge (Discovery® DSC-Si SPE Tube bed wt. 500 mg, volume 3 mL, from Supelco). Neutral lipids, glycolipids and PLFAs were eluted by chloroform, acetone and methanol, respectively. Methyl nonadecanoate (fatty acid methyl ester 19: 0) was added as an internal standard and PLFAs were *trans*-methylated under mild alkaline condition to yield fatty acid methyl esters (FAMES), (Dowling et al., 1986). FAMES were then analysed by GC/MS (4000 GC/MS, Varian) in split-less mode (1µL, injector temperature: 250°C) equipped with a BPX70 column (60 m, 0.25mm i.d., 0.25mm df. , SGE), and helium as a carrier gas. The temperature program was 50 °C for 5 min, raised to 165°C at 15°C/min, followed by a gradient of 2°C/min up to 225°C. This temperature was held for 15min. To

identify the FAMES, the retention times and the mass spectra were compared with those obtained from standards (Bacterial Acid Methyl Ester (BAME) Mix from Supelco and 11 Hexadecenoic acid (92% cis, 8% trans) from Matreya). Gram positive bacterial PLFAs were i15:0, a15:0, i16:0, i17:0 and gram negative bacterial PLFAs were 17:0cy, 19:0cy & 16:1 ω 9. Saprophytic fungal PLFAs were 18:1 ω 9c, 18:2 ω 9t and 18:2 ω 6c whereas mycorrhizal PLFA was 16:1 ω 5c.

III.6. Statistical analyses

Multifactor analysis of variance (ANOVA) was used to assess the difference between SOM mineralization in planted and bare soils (whole profile) by assuming plant presence, date of measurement and plant \times date as fixed factors. Similarly multifactor ANOVA was used to differentiate between SOM mineralization in soil layers obtained from planted and bare soil profiles. Plant presence, soil depth and plant \times soil depth were used as fixed factors. Linear regression was carried to determine relation between plant-derived ^{13}C respiration and rhizosphere priming effect. Multifactor ANOVA was used to determine the effect of plants, soil depth, days after incubation and their interactions on net N mineralization. To determine the effect of plants, soil depth and their interaction on relative abundances of PLFA, multifactor ANOVA was used. All statistical tests were performed with Statgraphics Plus (Manugistics, USA)

IV. Results

IV.1. SOM mineralization & rhizosphere priming effect

Living plants significantly accelerated the mineralization of SOM as compared to bare soil, throughout the duration of experiment i.e. induced rhizosphere priming effect (p -value < 0.05, Figure 1a). The cumulative *RPE* amounted 180% of SOM mineralization in bare soil (Figure 1b). The rhizosphere priming effect (*RPE*) started with the development of plants and was maintained for whole duration of experiment. The amount of *RPE* is positively correlated with the amount of unlabelled plant-derived C-CO₂ released, an indicator of rhizodeposits respired by the microbes (Figure 3). The SOM mineralization and *RPE* varied along the seasons i.e. higher *RPE* during plant growth season (April-September).

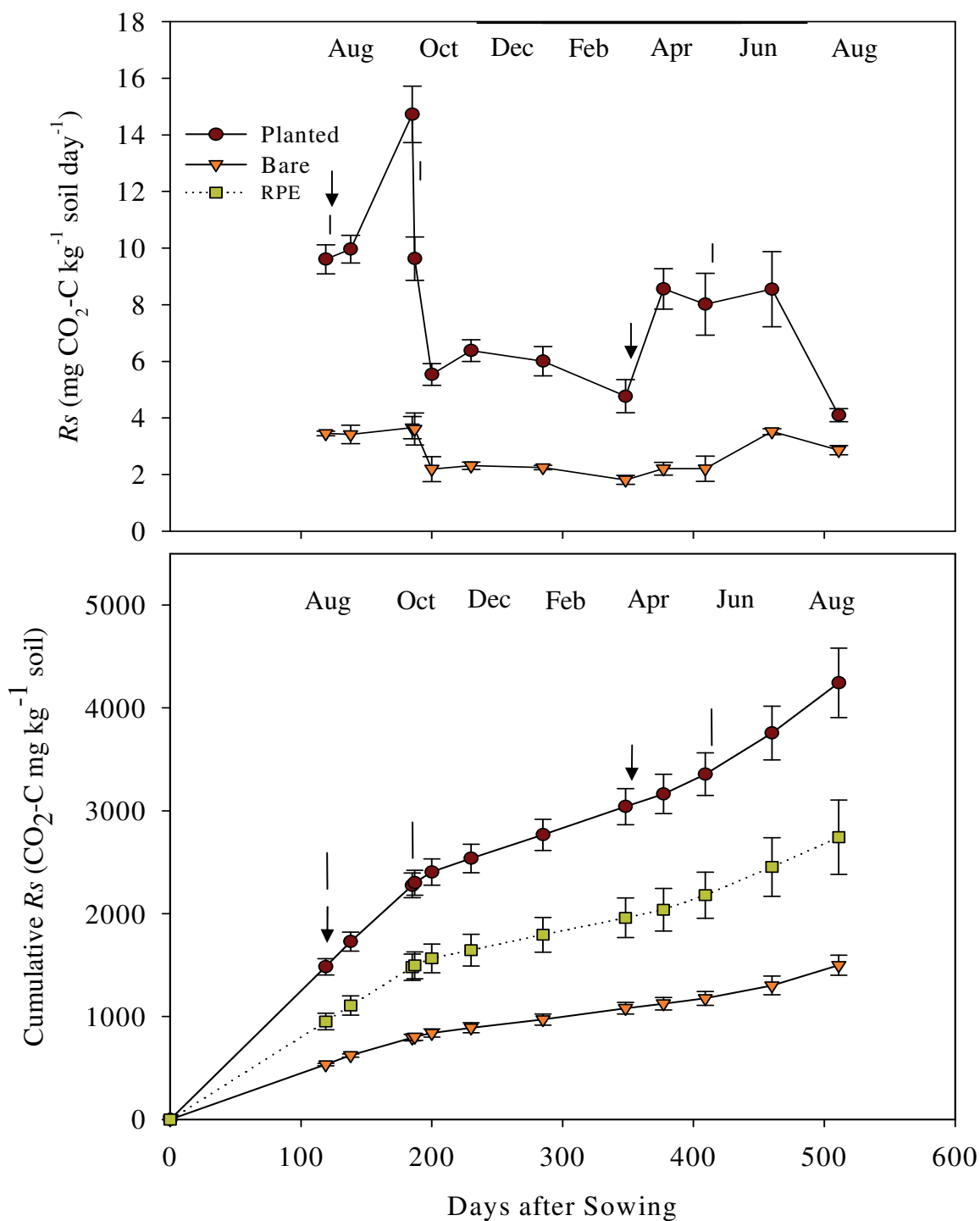

Figure 1: SOM mineralization i.e. soil-derived CO₂ (R_s) (CO₂-C mg kg⁻¹ soil day⁻¹) (a) Cumulative SOM mineralization (CO₂-C mg kg⁻¹ soil) for whole duration of experiment (b) in bare and planted soils. ↑ represents clipping (5 cm from soil) and ↓ represents fertilization.

The respiration measure from soil horizons corresponding to various depths of soil profile i.e. upper (10-33 cm), middle (33-56 cm) and deep (56-80 cm), showed that the SOM

mineralization in bare soils after 511 days of experiment is similar for the three horizons. The presence of plants significantly increased the SOM mineralization compared to bare soils in all the three horizons i.e. RPE was induced (p -value < 0.001, Figure 2). However there was a significant interaction between planting and soil depth (p -value < 0.01) and the SOM mineralization in planted upper soil horizon was the highest among all soil horizons and amounted 300% of that in bare soil. In middle and deep soil horizons of planted soils, the SOM mineralization was similar and corresponded to 156% and 166% respectively to that in bare soil. When the SOM mineralization of all three horizons is summed, the total SOM mineralization in planted profile was 209% of that in bare soil profile.

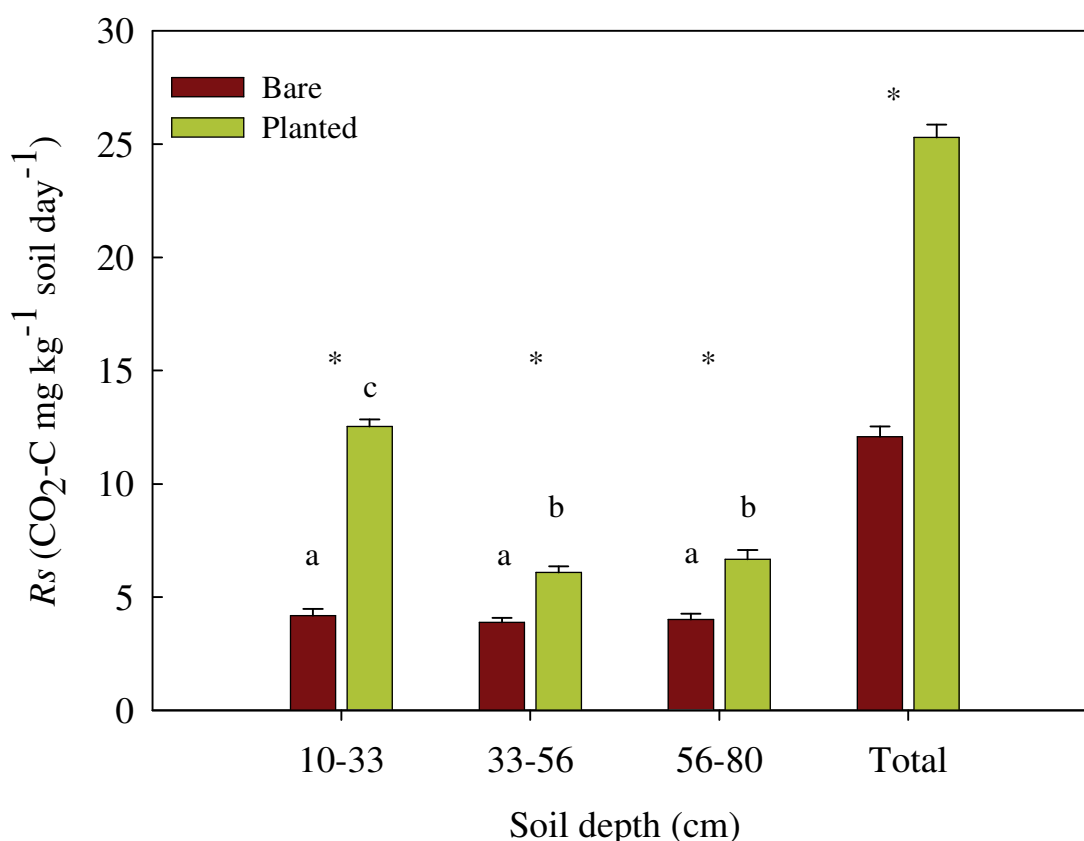

Figure 2: SOM mineralization i.e. soil-derived $\text{CO}_2\text{-C}$ (R_s) ($\text{mg kg}^{-1} \text{soil day}^{-1}$) along soil profile for bare and previously planted soils after lab incubation.

The ^{14}C contents and calculated ages of the soil C released as CO_2 from upper (10-33 cm) and deep soil horizons (56-80 cm) and different respiration compartments is shown in Table 1. For upper horizon of bare soil the mean age of soil C released is 1,174 (± 165) years BP. The presence of plants significantly decreased the ^{14}C content of released CO_2 indicating that the rhizosphere priming mobilized very old soil C. The calculations indicated that pool of soil C mineralized by RPE in upper soil horizon (10-33 cm) was 6004 (± 1021) years BP old. The mean age of C released from bare soil increased with depth from 1,174 (± 165) to 1,810 (± 210). Again the plant's presence in deep soil horizon (56-80 cm) decreased the ^{14}C content of C released as CO_2 . The mean age of soil C released by RPE in deep soil horizon was estimated to be 15,612 (± 2489) years BP.

Table 1: Quantity, ^{14}C activity and ^{14}C age of unlabelled (soil-derived) C released as CO_2 by bare, planted and rhizosphere priming effect during 7 days incubation of undisturbed soil layers obtained from intact soil profiles after 511 days of planting experiment. Values are given as means (n=4). Within parentheses are standard errors. Standard errors of ^{14}C age are asymmetric due to exponential decay of ^{14}C .

Soil depth		Quantity	^{14}C Activity	^{14}C Age
		(mg C kg ⁻¹ soil)	(MC %)	(Year BP)
Upper layer				
(10-33 cm)	Bare soil	29.29 (2.08)	86.76 (1.74)	1,174 (+167/ -164)
	Planted soil	87.72 (2.13)	60.45 (4.48)	4,162 (+637/-591)
	Rhizosphere priming effect	58.43 (2.98)	48.38 (5.94)	6,004 (1,084/-958)
Deep layer				
(56-80 cm)	Bare soil	24.07 (1.50)	80.34 (2.01)	1,810 (+210/ - 205)
	Planted soil	46.69 (2.82)	67.21 (1.61)	5,195 (+253/ -245)
	Rhizosphere priming effect	22.62 (3.19)	15.13 (4.42)	15,612 (+2,858/ -2,120)

IV.2. Mineral nitrogen in soil

The N contents extracted after 24 hours incubation of soil with ^{15}N during the gross N

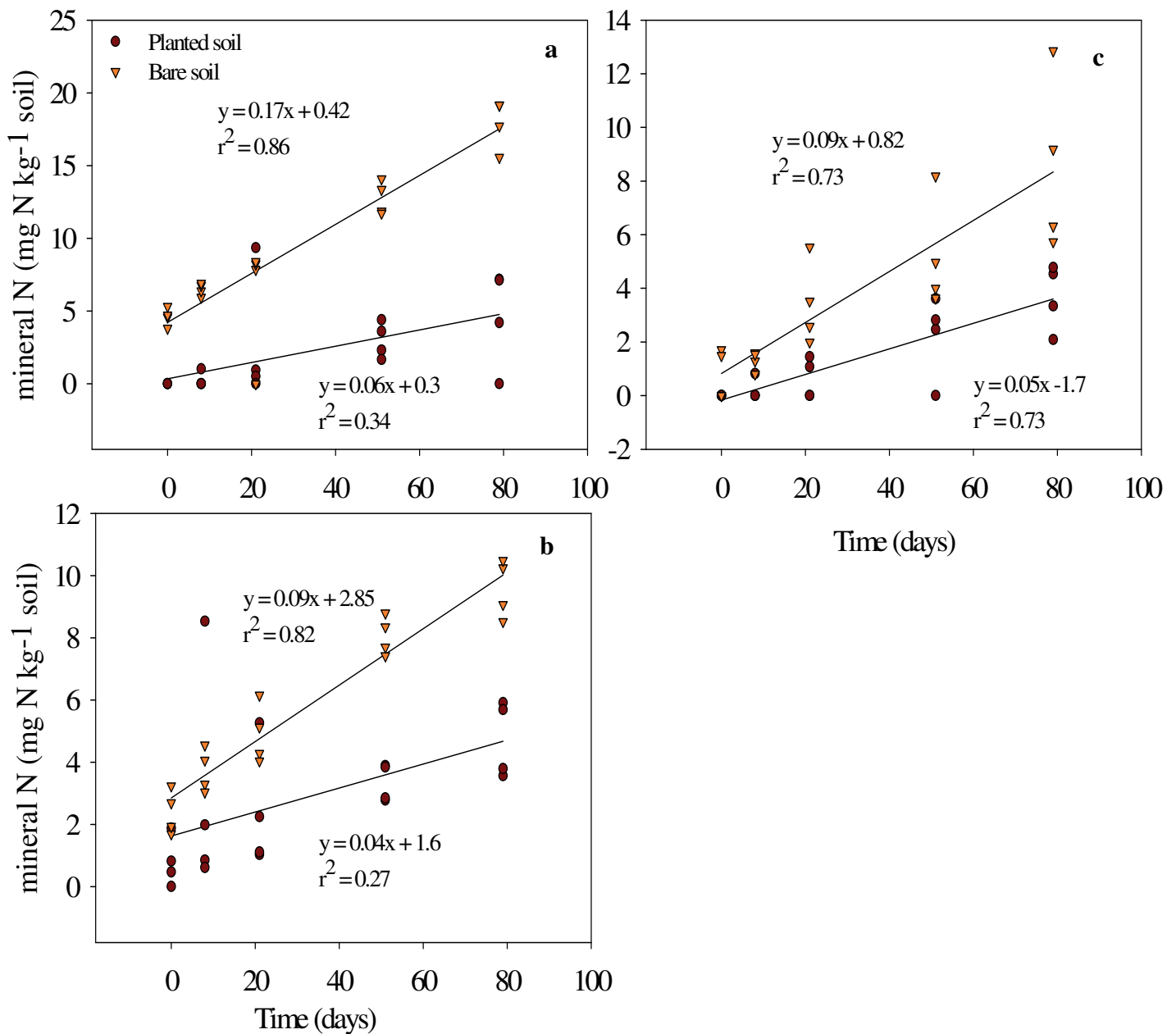

Figure 3: Net nitrogen mineralization in soils of upper (a) middle (b) and deep (c) horizons of planted and bare soils for 79 days of incubation.

measurement were not detectable. The dilution of ^{15}N pool could not be quantified hence gross N mineralization could not be calculated.

The N contents were zero or near to zero in three horizons of previously planted soils immediately after the pots were destroyed and sampled. Whereas, in all horizons of bare soil, mineral N contents varied from 0.80 mg N kg⁻¹ in the deep soil to 4.61 mg N kg⁻¹, in upper soil. Moreover, the mineral nitrogen contents accumulated at lower rates in previously planted soils than bare soils indicating higher net N mineralization rates in bare soils (Figure 3).

IV.3. Root litter and soil organic C

After 511 days of experiment, no root biomass was recovered in bare soils. In planted soils, it was observed that the roots were present along the whole soil profile. The maximum amount of root biomass was recovered from upper soil horizon (10-33 cm depth) which was 4.5 times more than that in deep soil horizon (56-80) and > 6 times more than that found in middle soil horizon (33-56 cm) (Table 2).

The contents of particulate organic matter (5mm<POM>1mm) increased significantly in all horizons of planted soil (p -value = 0.003) and there was decreasing gradient from upper to deep soil horizon (Table 2).

The total content of soil organic C did not change significantly along the soil profile for planted and bare soils (Table 2). The presence of plants did not change significantly the total content of soil organic C.

Table 2: Root biomass, particular organic matter and soil organic C in three horizons of planted soil, particulate organic matter and soil organic C in bare and planted soils.

Compartment	Treatment / Soil Depth (cm)	Total (g kg ⁻¹ soil)
Roots	Planted	
	10-33	6.11 (0.98)
	33-56	0.89 (0.19)
	56-80	1.37 (0.22)
	Soil depth	0.000
Particulate organic matter (POM)	Planted	
	10-33	1.63 (0.33)
	33-56	0.55 (0.08)
	56-80	0.31 (0.09)
	Bare	
	10-33	0.15 (0.02)
	33-56	Nil
	56-80	0.21 (0.03)
	<i>P</i> -values	
	Plant	0.003
Soil depth	0.035	
Soil organic C	Planted	
	10-33	24.87 (1.60)
	33-56	22.49 (0.70)
	56-80	25.17 (2.31)
	Bare	
	10-33	22.75 (2.08)
	33-56	20.89 (0.53)
	56-80	22.31 (1.67)
	<i>P</i> -values	
	Plant	0.072
Soil depth	0.257	

IV.4. Microbial biomass & community composition

The total PLFA, indicative of microbial biomass, decreased significantly down the soil profile (Table 3, *p*-value = 0.000). The presence of plants significantly increased the total PLFA in

the three horizons (p -value = 0.024) and the amount of total PLFA were correlated with SOM mineralization.

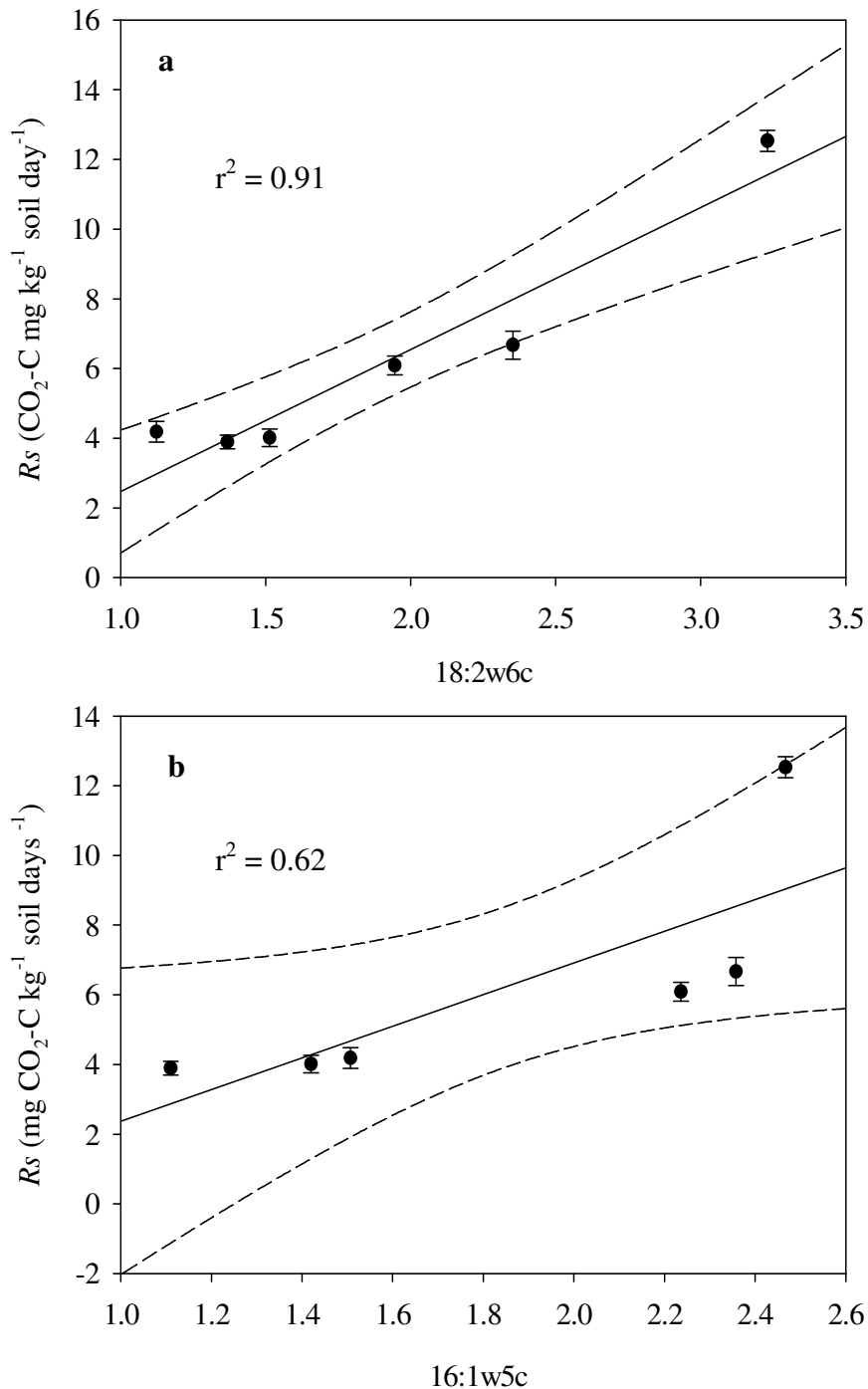

Figure 4: Correlation of saprophytic fungal biomarker 18:2 ω 6c (a) and arbuscular mycorrhizae 16:1 ω 5c with SOM mineralization i.e. soil-derived CO₂-C. (p -value <0.001, CI 95%).

Generally, the relative abundance of Gram positive and Gram negative bacteria increased down the soil profile (Table 3). In contrast the relative abundance of fungi decreased significantly down the soil profile except 18:2 ω 6c whose relative abundance remains constant along the profile of bare soil. The relative abundance of arbuscular mycorrhizal fungi (16:1 ω 5c) did not change significantly along soil depth (p -value = 0.252).

Plants significantly increased the relative abundance of saprophytic fungal biomarker i.e. 18:2 ω 6c as well as biomarker of arbuscular mycorrhizae i.e. 16:1 ω 5c (Table 3). The relative abundances of saprophytic fungi and arbuscular mycorrhizae correlated with the mineralization of SOM. However, the correlation involving saprophytic fungi was stronger than that involving mycorrhizae (Figure 4).

Planting did not alter significantly the relative abundance of any biomarker of Gram negative bacteria determined in this study i.e. 17:0cy, 19:0cy and 16:1 ω 9c (Table 3). However, the relative abundance of all Gram positive bacteria significantly increased under planting except that of i17:0 which decreased significantly in planted soils. There was no correlation between abundance of any of Gram positive bacteria and SOM mineralization.

Table 3: Mean relative abundance of individual PLFA biomarkers (mol PLFA C %) in planted and bare soils along soil depth. *p*-values show result of multifactor ANOVA. * represents absolute value (nmol g⁻¹ of dry soil) of measured PLFA.

Soil depth (cm)	Fungi		AMF		Gram (-)		Gram (+)				Total PLFA*	
	18:1 ω 9t	18:1 ω 9c	18:2 ω 6c	16:1 ω 5c	17:0cy	19:0cy	16:1 ω 9c	i15:0	a15:0	i16:0		i17:0
<i>Planted soil</i>												
10-33	3.80 (0.18)	19.73 (1.10)	3.23 (0.39)	2.47 (0.14)	6.10 (0.41)	1.60 (0.09)	5.50 (0.42)	4.01 (0.31)	4.80 (0.82)	7.89 (0.61)	7.20 (0.32)	304.77 (35.31)
33-56	4.81 (0.44)	17.59 (0.74)	1.94 (0.18)	2.24 (0.21)	9.38 (0.24)	2.48 (0.24)	6.76 (0.44)	3.50 (0.66)	2.87 (0.54)	7.11 (0.45)	8.51 (0.33)	123.1 (11.02)
56-80	3.38 (0.53)	12.48 (1.29)	2.35 (0.06)	2.36 (0.15)	8.39 (0.93)	1.71 (0.25)	8.87 (0.59)	9.12 (1.79)	6.17 (1.42)	8.62 (0.65)	7.17 (0.68)	170.96 (44.04)
<i>Bare soil</i>												
10-33	4.86 (1.15)	22.52 (4.74)	1.12 (0.13)	1.51 (0.37)	5.88 (0.51)	1.75 (0.49)	4.49 (1.09)	2.16 (2.11)	0.57 (0.35)	5.66 (1.36)	7.78 (0.59)	229.79 (81.33)
33-56	6.29 (1.04)	20.83 (1.89)	1.37 (0.07)	1.11 (0.18)	8.91 (0.28)	3.23 (0.80)	4.80 (0.65)	1.68 (0.56)	1.62 (0.39)	4.59 (0.65)	9.43 (0.31)	68.47 (7.62)
56-80	4.00 (0.59)	14.09 (1.86)	1.51 (0.18)	1.42 (0.16)	7.85 (0.51)	2.59 (0.55)	11.06 (1.52)	5.64 (1.42)	3.73 (0.96)	7.68 (0.57)	8.94 (0.66)	85.57 (17.49)
<i>P-value</i>												
Planting	0.099	0.141	0.000	0.000	0.576	0.088	0.181	0.013	0.001	0.002	0.007	0.024
Soil depth	0.029	0.003	0.160	0.252	0.000	0.030	0.000	0.000	0.006	0.010	0.011	0.000
Planting \times Soil depth	0.964	0.916	0.001	0.864	0.683	0.639	0.081	0.667	0.244	0.470	0.397	0.909

V. Discussion

Rhizosphere priming effect reveals instability of deep soil C

Our results confirm that deep rooted plants are capable of accelerating the mineralization of deep SOM. The rhizosphere priming effect *RPE* thus induced by deep roots mobilized soil organic C that was stabilized for more than 15,000 years (Figure 2, Table 1). This indicates that in the presence of energy, the mineralization capability of deep soil microbes is very important and perhaps no form of C can resist microbial oxidation i.e. the inert or passive pools defined in soil C models are degradable.

Our results support the hypothesis of Fontaine et al., (2007) that the stability of deep soil C is due to the energy limitation of microbes. They suggested that in the absence of fresh C the microbes can not mineralize humified recalcitrant SOM for long term because the energetic expense to synthesize the extra cellular enzymes and maintain cellular activity is more than the return they could get from SOM mineralization. This strong dependence of microbial mineralization of SOM on the supply of fresh C is shown in our experiment (Figure 5) with strong correlation between *RPE* and fresh C (labelled) respired from planted soils. This dependence could explain the seasonal fluctuation of *RPE* with plant growth seasons resulting in production of higher biomass and *RPE* (Figure 1a, Dijkstra et al., 2006).

Accelerated SOM mineralization in planted soils shows that herbaceous plants are capable of inducing rhizosphere priming effect in unperturbed soil profiles as in shallower and perturbed soils (Shahzad et al. *unpublished*, First chapter of this thesis). Moreover, this *RPE* was maintained for more than 500 days and occurred in all soil horizons. Collectively, these results indicate that a substantial part of soil C, comprising even the C that is considered inert, is vulnerable to *RPE*. They signify that priming effect and its mechanisms (mineralization rate driven by microbial activity and diversity, energy availability etc.) should be included in models in order to predict consequences of global vegetation changes,

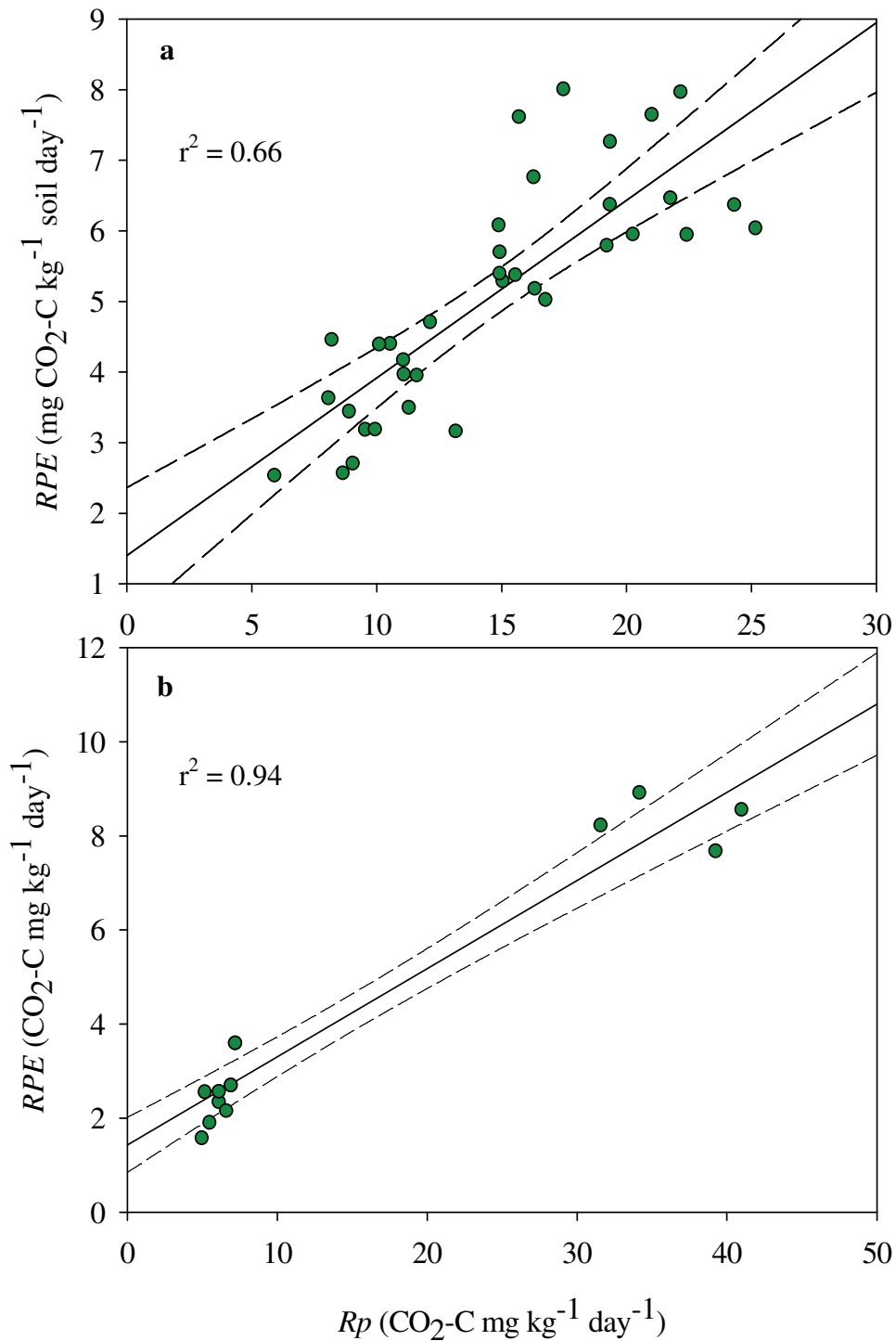

Figure 5: Relationship between plant-derived respiration (R_p) and rhizosphere priming effect (RPE) in entire soil profile for planted soils for whole duration of experiment (a) and in soil horizons of previously planted soil profiles after lab incubation (b).

specifically the associated change in plant rooting depths, on soil C storage.

The ^{14}C age of $\text{CO}_2\text{-C}$ released from upper horizon (10-33 cm) of bare soil (1,174 \pm 165 years BP) is older than that reported by Fontaine et al. (2007) on same site (< 50 yrs). However our study used 10-33 cm horizon of soil whereas Fontaine et al., (2007) used 0-20 cm. Given that the most of root biomass is concentrated in first 10 cm of soil profile, the entry of recent fresh C in 10-33 cm horizon is relatively lower than in the 0-20 horizon studied by Fontaine et al., (2007). Moreover, the ^{14}C dating on $\text{CO}_2\text{-C}$ released from bare soils in our study was done after 511 days of incubation in the absence of fresh C supply. These two reasons explain why the recent fresh C content in the 10-33 cm horizon used in this study is ten times less than in the 0-20 cm horizon studied by Fontaine et al., (2007). As a result, the contribution of recent fresh C in total soil respiration is higher in the study of Fontaine et al., (2007) than our study contributing to the observed difference in mean age.

Our experiment was not able to determine whether the increased SOM mineralization in planted soils could result in higher release of N from SOM. Indeed, the added ^{15}N was completely immobilized in previously planted soil after 24 hours of incubation and it was impossible to measure gross N mineralization. The deposition of fresh C in planted soils could have accelerated the immobilization of mineral N by increased microbial biomass in planted soils (Jonasson et al., 1996; Schmidt et al., 1997; Dijkstra et al., 2006). Moreover, the high immobilization of nitrogen in planted soils induced significantly lower net N mineralization as compared to that in bare soils (Figure 4). Therefore, our study encourages future research on whether the *RPE* induced by deep plant roots in deep soil layers could increase the mineral N availability from ancient SOM and its uptake by plant. This research should apply larger quantity of ^{15}N labelled mineral N than previously suggested (Barraclough 1991) in order to quantify gross N mineralization in grasslands. Moreover, the

resins can be used to simulate plant N uptake during soil incubation with fresh C and quantify the N release from SOM due to priming effect.

The strong correlation between the saprophytic fungal biomarker (18:2 ω 6c) and SOM mineralization (Figure 5) concurs with previous lab incubations (Fontaine et al., 2011) and experiment with plants (First chapter of this thesis) showing that this is the only biomarker that is positively linked to priming effect. Collectively, these results suggest that the fungi represented by this biomarker are key actors in mineralization of SOM and *RPE*. It is interesting to note that this biomarker is present in deep soil horizons and is stimulated by the rhizodeposition of deep roots of *Festuca arundinaceae*. Thus, the stability of deep soil C is mainly due to limitation of energy for microbial activity and not due to a lack of SOM mineralizing microbes in deep soil. Moreover, the fact the priming effect is induced by the fungi which have hyphae structures signify that two distinct theories for explaining the stability of deep soil C, i.e. energy limitation of microbes (Fontaine et al., 2007) and spatial separation between microbial and soil C distributions (Salomé et al., 2010, Schimel et al., 2011), can be merged. Indeed, the spatial separation between deep soil C and microbial biomass is due to the lack of energy for the fungi to construct their hyphae which allow them to colonize soil volumes and access thinly dispersed SOM reserves.

Our results also show positive correlation between mycorrhizae (16:1 ω 5c) and SOM mineralization (Figure 5). It is commonly believed that the enzymatic and degradation capabilities of mycorrhizae are limited suggesting this correlation could not have cause-and-effect link. For example, mycorrhizae depend on root biomass which also determines the amount of fresh C supplied in soil and thereby the *RPE* intensity. However, Hodge et al. (2001) have suggested that the ability of some arbuscular mycorrhizal fungus to accelerate decomposition and acquire nitrogen directly from organic material. We therefore encourage

new investigation to test directly test the role of mycorrhizae in recalcitrant SOM mineralization.

VI. Conclusion

Our study showed conclusively that the organic carbon in deep soil layers of a Cambisol is stable due to energy limitation (limited supply of labile C) of microbes. A deep rooted grassland plant, *Festuca arundinacea*, has been shown to induce the mineralization of almost 15,000 years old C from deep soil by stimulating and changing the microbial community through rhizodeposition. Moreover, our study supports the previous idea that the saprophytic fungi represented by 18:2 ω 6c biomarker are key actors in SOM mineralization and *RPE*. The vulnerability of deep soil C to rhizosphere priming effect in response to labile C supply warrants further research on the proposals of incorporation of organic matter in deep soils for its sequestration there implying its long term stabilization (Lorenz and Lal 2005). We suggest long term field experiments to assess net balance of deep soil C between emissions from and sequestration in deep soil under deep rooted plants

VII. References

- Barraclough, D., 1991. The use of mean pool abundances to interpret ^{15}N tracer experiments
I. Theory. *Plant and Soil* 131, 89-96.
- Batjes, N.H., 1996. Total carbon and nitrogen in the soils of the world. *European Journal of Soil Science* 47, 151-163.
- Bernard, L., Mougél, C., Maron, P.-A., Nowak, V., Lévêque, J., Henault, C., Haichar, F.e.Z., Berge, O., Marol, C., Balesdent, J., Gibiat, F., Lemanceau, P., Ranjard, L., 2007. Dynamics and identification of soil microbial populations actively assimilating carbon from ^{13}C -labelled wheat residue as estimated by DNA- and RNA-SIP techniques. *Environmental Microbiology* 9, 752-764.
- Bligh, E.G., Dyer, W.J., 1959. A rapid method of total lipid extraction and purification. *Canadian Journal of Biochemistry and Physiology* 37, 911-917.
- Boivin, P. et al., 2004. *Volcanologie de la Chaîne des Puys. Parc naturel régional de la chaîne des puys*, Clermont Ferrand.
- Cheng, W., Johnson, D.W., Fu, S., 2003. Rhizosphere effects on decomposition: controls of plant species, phenology, and fertilization. *Soil Science Society of America Journal*. 67, 1418-1427.
- Dijkstra, F.A., Cheng, W., 2007. Interactions between soil and tree roots accelerate long-term soil carbon decomposition. *Ecology Letters* 10, 1046-1053.
- Dijkstra, F.A., Cheng, W., Johnson, D.W., 2006. Plant biomass influences rhizosphere priming effects on soil organic matter decomposition in two differently managed soils. *Soil Biology and Biochemistry* 38, 2519-2526.
- Dijkstra, F.A., Hutchinson, G.L., Reeder, J.D., LeCain, D.R., Morgan, J.A., 2011. Elevated CO_2 , but not defoliation, enhances N cycling and increases short-term soil N

- immobilization regardless of N addition in a semiarid grassland. *Soil Biology and Biochemistry* 43, 2247-2256.
- Dowling, N.J.E., Widdel, F., White, D.C., 1986. Phospholipid ester-linked fatty acid biomarkers of acetate-oxidizing sulphate-reducers and other sulphide-forming bacteria. *Journal of General Microbiology* 132, 1815-1825.
- Fontaine, S., Barot, S., Barre, P., Bdioui, N., Mary, B., Rumpel, C., 2007. Stability of organic carbon in deep soil layers controlled by fresh carbon supply. *Nature* 450, 277-280.
- Fontaine, S., Henault, C., Aamor, A., Bdioui, N., Bloor, J.M.G., Maire, V., Mary, B., Revalliot, S., Maron, P.A., 2011. Fungi mediate long term sequestration of carbon and nitrogen in soil through their priming effect. *Soil Biology and Biochemistry* 43, 86-96.
- Frostegard, A., Tunlid, A., Baath, E., 1991. Microbial biomass measured as total lipid phosphate in soils of different organic content. *Journal of Microbiological Methods* 14, 151-163.
- Hodge, A., Campbell, C.D., Fitter, A.H., 2001. An arbuscular mycorrhizal fungus accelerates decomposition and acquires nitrogen directly from organic material. *Nature* 413, 297-299.
- Jobbagy, E.G., Jackson, R.B., 2000. The vertical distribution of soil organic carbon and its relation to climate and vegetation. *Ecological Applications* 10, 423-436.
- Jonasson, S., Michelsen, A., Schmidt, I.K., Nielsen, E.V., Callaghan, T.V., 1996. Microbial biomass C, N and P in two arctic soils and responses to addition of NPK fertilizer and sugar: implications for plant nutrient uptake. *Oecologia* 106, 507-515.
- Lorenz, K., Lal, R., Donald, L.S., 2005. The depth distribution of soil organic carbon in relation to land use and management and the potential of carbon sequestration in subsoil horizons. *Advances in Agronomy*. Academic Press, pp. 35-66.

- Loiseau, P., Soussana, J.F., 1999. Elevated [CO₂], temperature increase and N supply effects on the turnover of below-ground carbon in a temperate grassland ecosystem. *Plant and Soil* 210, 233-247.
- Nottingham, A.T., Griffiths, H., Chamberlain, P.M., Stott, A.W., Tanner, E.V.J., 2009. Soil priming by sugar and leaf-litter substrates: A link to microbial groups. *Applied Soil Ecology* 42, 183-190.
- Personeni, E., Loiseau, P., 2004. How does the nature of living and dead roots affect the residence time of carbon in the root litter continuum? *Plant and Soil* 267, 129-141.
- Rumpel, C., Kögel-Knabner, I., 2011. Deep soil organic matter- a key but poorly understood component of terrestrial C cycle. *Plant and Soil* 338, 143-158.
- Salomé, C., Naoise, N., Valérie, P., Thomas Z, L., Claire, C., 2009. Carbon dynamics in topsoil and in subsoil may be controlled by different regulatory mechanisms. *Global Change Biology* 16, 416-426.
- Schimel, J.P., Wetterstedt, J.Ã.M., Holden, P.A., Trumbore, S.E., 2011. Drying/rewetting cycles mobilize old C from deep soils from a California annual grassland. *Soil Biology and Biochemistry* 43, 1101-1103.
- Schmidt, I.K., Michelsen, A., Jonasson, S., 1997. Effects of labile soil carbon on nutrient partitioning between an arctic graminoid and microbes. *Oecologia* 112, 557-565.
- Sombroek, W.G., Nachtergaele, F.O., Hebel, A., 1993. Amounts, dynamics and sequestering of carbon in tropical and subtropical soils. *Ambio* 22, 417-426.
- Trumbore, S., 2000. Age of soil organic matter and soil respiration: radiocarbon constraints on belowground C dynamics. *Ecological Applications* 10, 399-411.

CHAPTER 4

Temperature response of organic C mineralization: a new experimentally tested theory based on enzyme inactivation and microbial energy limitation reconciles the results of lab and ecosystem experiments

***TEMPERATURE RESPONSE OF ORGANIC C
MINERALIZATION: A NEW EXPERIMENTALLY TESTED
THEORY BASED ON ENZYME INACTIVATION AND
MICROBIAL ENERGY LIMITATION RECONCILES THE
RESULTS OF LAB AND ECOSYSTEM EXPERIMENTS***

Tanvir SHAHZAD^a, Gaël ALVAREZ^{a,c}, Claire CHENU^b, Vincent MAIRE^a, Nazia PERVEEN^a, Sébastien FONTAINE^{a*}

Postal address:

^aUR 874, INRA-UREP. 234- Avenue du Brézet 63100 Clermont Ferrand, France.

^bUMR BIOEMCO (Biogéochimie et Ecologie des Milieux Continentaux) AgroParisTech
Grignon 78850 Thiverval Grignon France.

^cClermont Université, VetAgro Sup, 63000, Clermont-Ferrand, France.

Email Address:

hereistanvir@gmail.com

gael.alvarez@vetagro-sup.fr

claire.chenu@grignon.inra.fr

vmaire24@gmail.com

nazia.perveen@clermont.inra.fr

sebastien.fontaine@clermont.inra.fr

*Author for correspondence

Tanvir SHAHZAD

Email: hereistanvir@gmail.com

Telephone: +33 626 93 81 82

Fax: +33 473 62 44 57

I. Summary

The kinetic theory predicts an increase in organic matter (OM) mineralization with increasing temperature. This prediction has been supported by the results of a number of short term soil incubation studies. However, soil-warming long term field experiments have shown that temperature has no effect on OM mineralization in long term. Moreover, generalization of gas exchange measurement to many ecosystems has shown that soil respiration under warm ecosystems is relatively lower than cold ones (except arctic ecosystems where soil processes come to halt due to frost). In an attempt to reconcile this difference in theory, soil incubations and soil warming experiments, here we present a simple model that includes two key processes. First, microbial decomposers are limited by fresh energy-rich C which controls their enzyme production capability to mineralize recalcitrant C in soil. Second, enzyme inactivation, occurring due to the loss of three dimensional structures of enzymes induced by the Brownian movement, accelerates with warming. The analysis of the model stress on the need of separating non steady-state-system like incubated bare soil wherein there is a continuous decrease in enzymatic pool, from a steady-state-system where the enzymatic pool is maintained by microbes which are supplied with fresh C like in soil-plant system. The model predicts that soil C mineralization should increase with temperature till an optimum in bare soil whereas it should continuously decrease with temperature in planted soil. These predictions were confirmed by an experiment on planted soil and bare soil systems submitted to seasonal temperature variation for 479 days.

Keywords:

Soil organic carbon, temperature, enzyme inactivation, energy limitation, ¹³C-labelling

II. Introduction

Arrhenius equation (Arrhenius, 1889) has been used to describe the relationship of the velocity of a reaction with temperature either in its original form (Thierron and Laudelout, 1996) or in modified forms (Eyring 1935; Lloyd and Taylor, 1994). This equation is given as:

$$k = a.e^{(-EA / RT)} \quad (1)$$

where k is the reaction rate, a is a pre-exponential factor, corresponding to the theoretical reaction rate in the absence of activation energy, EA is the required activation energy to start a reaction; R is the gas constant and T is temperature (K). This equation predicts an increase in organic matter mineralization with increasing temperature. It also predicts that the temperature response of organic matter mineralization increases with its recalcitrance (i.e. higher EA values). The predictions of this equation are supported by short term enzyme assays (Daniel and Danson 2010) and soil incubations (Kirschbaum, 1995; Waldrop and Firestone, 2004; Knorr et al., 2005) which show a positive relationship between temperatures, enzymatic activities and soil respiration till an optimum temperature. They are also supported by the general positive relationship between daily fluctuations of temperature and those of ecosystem respiration fluxes measured in ecosystems by eddy covariance (Pilegaard et al., 2001). However, a meta-analysis on twenty ecosystems along latitudinal gradient showed that the mean annual temperature is positively related to the annual net ecosystem productivity (i.e. annual C fixation by ecosystem) suggesting that soil respiration under warm ecosystems is relatively lower than cold ones (Sanderman et al., 2003). It must be noted that this study does not include arctic ecosystems (Tundra, Taiga) where soil and plant processes are stopped by the frost for most of the year. Moreover, soil warming field experiments have shown that the temperature-induced acceleration in soil respiration only occurs for few years and the

effect of temperature on soil respiration subsides in the long term (Melillo et al., 2002; Eliasson et al., 2005). These results suggested that mineralization of the large pool of recalcitrant C present in soils is not accelerated by warming (Giardina and Ryan 2000).

To reconcile these differences between theory, results of soil incubations and field experiments, here we present an alternative theory to explain the effect of temperature on velocity of enzymatic reactions and recalcitrant organic matter mineralization. This theory was tested in a soil-plant experiment quantifying the effect of temperature on recalcitrant soil organic carbon (C_r) mineralization.

III. Theory

In this alternative theory, we take into account two key processes which are often overlooked while modeling or describing the experimental results of effect of temperature on enzymatic activities and organic matter mineralization.

1) Energy limitation of microbial decomposers: the availability of fresh energy-rich substrates supplied by autotrophs (plant, phytoplankton) is low and limiting for decomposer communities in terrestrial and aquatic ecosystems (Paul and Clark, 1989; Guenet et al., 2010). Moreover, the recalcitrant organic matters, which constitute major form of C present in terrestrial and aquatic ecosystems, are too poor in available energy to sustain biological activity (Fontaine et al., 2007; Guenet et al., 2010). The decomposers degrade recalcitrant organic matters through co-metabolism with fresh energy-rich substrates (Bingeman et al., 1953; Kuzyakov 2000). This energy limitation of decomposers that produce enzymes must be taken into account to predict the effect of temperature on enzymatic reactions.

2) Temperature dependent inactivation of enzymes: the enzymes undergo inactivation along the course of time due to loss of their three dimensional structure induced by Brownian movement (Massey et al., 1966). The temperature increase accelerates the Brownian movement and hence the inactivation of enzymes. Although this inactivation of enzymes is

taken into account in enzymology, this process is not considered to explain the response of ecosystems to temperature changes.

The mineralization of recalcitrant soil organic C (C_r) can be modelled as an enzymatic reaction where the substrate (C_r) is not limiting (Fontaine and Barot 2005) and the rate of reaction (V_{\max}) depends on the concentration of active enzyme (E) and the temperature-dependent specific catalytic activity of enzymes (k_{cat}):

$$V_{\max} = \frac{d[C_r]}{dt} = k_{\text{cat}} \cdot [E] \quad (1)$$

The concentration of active enzymes in soil can be determined as the difference between microbial production of new enzymes and inactivation of enzymes. The production of enzymes is limited by the flux of fresh energy-rich substrates (Φ_f) and the inactivation rate of enzymes (k_{inact}) is temperature dependent:

$$\frac{d[E]}{dt} = \omega \cdot \Phi_f - k_{\text{inact}} \cdot [E] \quad (2)$$

where ω is the fraction of fresh substrates that microbes allocate to synthesize enzymes.

The specific catalytic activity (k_{cat}) and the inactivation rate of enzymes (k_{inact}) can be determined using Arrhenius equation:

$$k_{\text{cat}} = A \cdot e^{-EA_{\text{cat}}/RT} \quad (3)$$

$$k_{\text{inact}} = A \cdot e^{-EA_{\text{inact}}/RT} \quad (4)$$

The integration of these equations with respect to time gives:

$$V_{\max}(t) = k_{\text{cat}} \cdot \left[\frac{\omega \cdot \Phi_f}{k_{\text{inact}}} (1 - e^{-k_{\text{inact}} \cdot t}) + [E_0] \cdot e^{-k_{\text{inact}} \cdot t} \right] \quad (5)$$

where $[E_0]$ is the concentration of enzymes at time zero.

In enzyme assays, there is an initial concentration of enzymes that is inactivated with time and there is no production of new enzymes. In soil incubations, there is no supply of fresh energy and this system can be considered as an enzyme assay where there is continuous inactivation of enzymes with time. For explaining the results from such experiments, we can simplify Eq. (5) by setting $\Phi f = 0$ and determine the decrease in catalytic enzymatic activity with time in this non steady state system ($V_{\max ns}$):

$$V_{\max ns}(t) = k_{cat} \cdot [E_0] e^{-k_{inact} \cdot t} \quad (6)$$

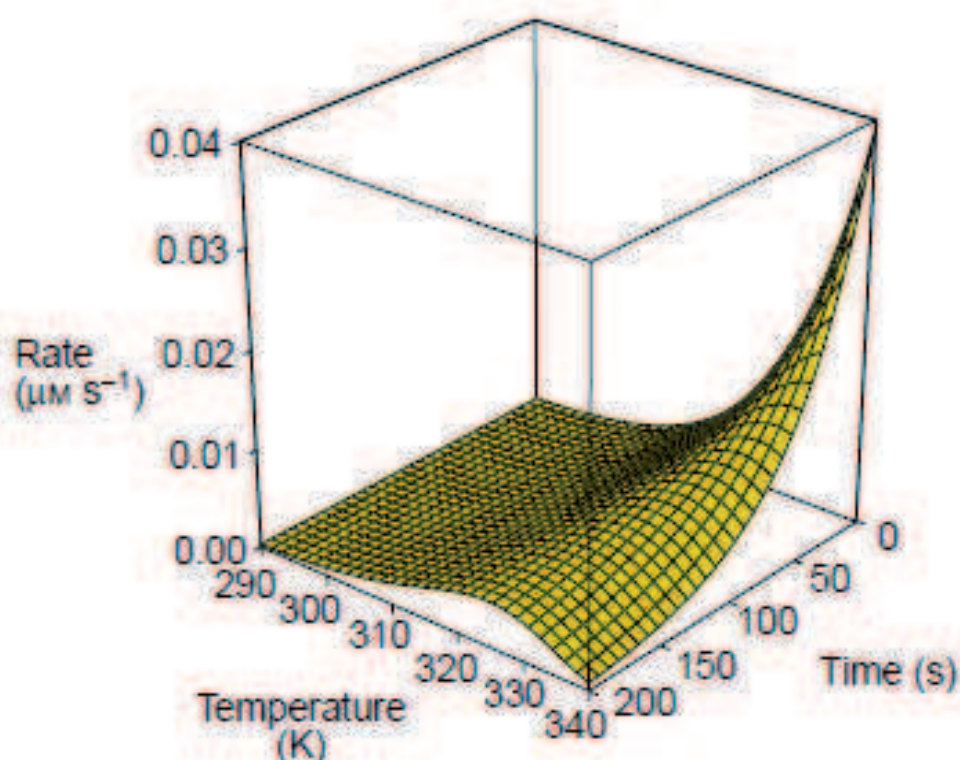

Figure 1. Temperature dependence of enzyme activity in an enzyme assay. The variation of enzyme activity with temperature (290-340 K) and time (0-200 s) during the assay was simulated using Eq 6 with following parameter values $k_{cat} = 80 \text{ KJ mol}^{-1}$, $k_{inact} = 95 \text{ KJ mol}^{-1}$, total enzyme concentration = 100 nM.

Figure 1 shows that this equation predicts an increase in enzymatic activity (mineralization of recalcitrant soil C for example) with temperature till an optimum

temperature beyond which temperature-induced inactivation of enzymes is greater than temperature-induced stimulation of specific enzymatic activity. It is interesting to note that Eq. 6 corresponds to the classical equation used by enzymologists to depict the variation of enzymatic activity with temperature and time (Copeland 2000).

In ecosystems, there is continuous production of new enzymes by soil microorganisms that compensates for the fraction of enzymes that is being inactivated. In such ecosystems, the enzymatic pool is maintained over long term thanks to generations of microorganisms that succeed. Mathematically, this maintenance of enzymatic pool over long term can be assimilated to a system at steady state. Therefore, the equations 1 & 2 were set to zero in order to calculate size of enzymatic pool (E^*) and velocity of enzymatic reaction (V_{\max}^*) when the system is at steady state:

$$E^* = \frac{\omega \cdot \Phi_f}{k_{inact}} \quad (7)$$

$$V_{\max}^* = k_{cat} \cdot \frac{\omega \Phi_f}{k_{inact}} \quad (8)$$

$$V_{\max}^* = \omega \cdot \Phi_f \cdot e^{\left(\frac{EA_{inact} - EA_{cat}}{RT}\right)} \quad (9)$$

According to Eq. 9, the effect of temperature on velocity of an enzymatic reaction at steady state is thus determined by difference between energies of activation required for enzyme inactivation (EA_{inact}) and specific enzyme activity (EA_{cat}). As shown by Figure 2, model analyzed at steady state does not predict an optimum temperature for enzyme activity. In contrast, enzymatic reaction decreases or increases continuously with temperature depending on the difference between energies of activation i.e. EA_{inact} & EA_{cat} . In literature, EA_{inact} has always been found higher than EA_{cat} (Peterson et al., 2007; Daniel and Danson 2010)

signifying that the increase with temperature of the rate of enzymes inactivation (k_{inact}) is higher than that of catalytic enzymatic activity (k_{cat}). In this case, our theory predicts a negative relationship between temperature and enzymatic reactions at steady state.

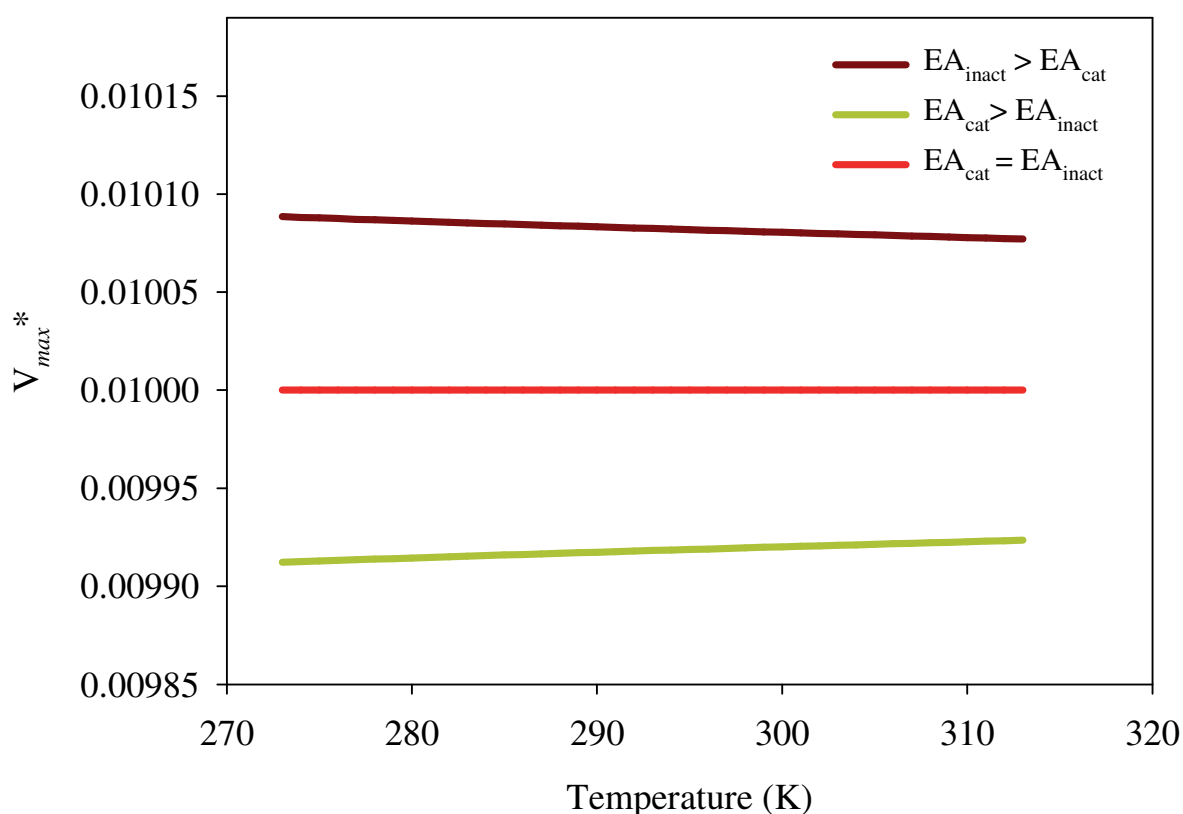

Figure 2. Effect of temperature on the velocity of an enzymatic reaction in a steady-state system as predicted by Eq. 9. Depending on values of EA_{inact} and EA_{cat} the temperature response of enzymatic reaction (V_{max}^*) can be positive, negative or null.

Our theory may help reconciling the apparent contradiction between lab experiments and long term field observations and experiments. In non-steady state system i.e. where there is no production of new enzymes and the proportion of inactivated enzymes depends on time, our theory (Eq. 6) predicts positive relation between temperature and enzymatic activity until an optimum temperature. This prediction is coherent with the results of lab experiments. In contrast when analyzed at steady state, our theory predicts a negative relationship between temperature and recalcitrant organic matter mineralization rate (Eq. 9). This new hypothesis

may explain the positive relationship between mean annual temperatures along a latitudinal gradient with net ecosystem productivity. It may also explain why soil warming in field experiment does not induce long term loss of soil organic matter.

IV. Experimental test

Using experimental approach, we aimed to determining the relationship between temperature and recalcitrant organic C mineralization in a plant-soil system near to steady state i.e. a system where there is a continuous supply of fresh substrate and microbial production of new enzymes. Plant-soil system consisted of a grassland species, *Lolium perenne*, was grown on subsoil where major form of C is recalcitrant. The soil-plant system was placed in a mesocosm for 479 days where plants benefited from natural light and temperature and were continuously exposed to ^{13}C labelled CO_2 . The continuous ^{13}C labelling of plants permitted to separate soil-derived recalcitrant C from soil-plant derived fresh C (^{13}C) during measurement of respiration of plant-soil system. Systems with bare soil were also prepared in order to determine the response of non-steady-state system to temperature. The seasonal temperature variation was used to determine the effect of temperature on recalcitrant C mineralisation. Given that the mean residence time of enzymes in soil solution is relatively short (hours-days), we considered that the pool of enzymes (E^*) and hence the mineralization rate (V_{\max}^*) at a given time i are in equilibrium at the temperature (T_i) and the flux of fresh C (Φ_{fi}) of the moment. Thus for each equilibrium (i), we calculate the mineralization of recalcitrant soil C ($V_{\max i}^*$) as:

$$V_{\max i}^* = \omega \cdot \Phi_{fi} \cdot e^{\left(\frac{EA_{inact} - EA_{cat}}{RT_i}\right)} \quad (10)$$

In order to determine the effect of temperature independently of the flux of fresh C, the mineralization of recalcitrant soil C ($V_{\max i}^*$) was expressed per unit of flux of fresh C:

$$\frac{V_{\max i}^*}{\Phi_{fi}} = \omega.e \left(\frac{EA_{inact} - EA_{cat}}{RT_i} \right) \quad (11)$$

The effect of temperature on mineralization of recalcitrant soil C was quantified on six other grassland species using the same approach in order to generalize the results of our theory at steady state. On the basis of model predictions, we hypothesized that the recalcitrant soil organic C mineralization should increase with temperature in bare soil whereas it should decrease with temperature in planted soil.

V. Materials and methods

V.1. Soil sampling and experimental design

The soil used in this experiment was sampled from an upland grassland located in the environmental research observatory (ORE) established by the French National Institute for Agricultural Research (INRA) in central France in 2003 (Theix, 45°43'N, 03°01'E). The local climate is semi-continental, with a mean annual temperature of 9°C and an average annual rainfall of 760mm. Before 2003, the site was managed as permanent grassland for more than 50 years (Fontaine et al., 2007). The soil is a drained Cambisol developed from granitic rock. For sampling, the upper 10 cm of soil profile were removed because it is rich in fresh C (Fontaine et al, 2007). Soil was taken from 10-40 cm soil profile where the humified recalcitrant organic matter is the major form of C. The fresh soil was sieved at 5 mm and was filled in PVC pots. Each pot was of 40 cm height and 9.8 cm internal diameter and contained 2.87 kg of dry soil. The soil properties were: pH 6.1±0.21; clay (%) 27±1.3; soil organic carbon (g kg⁻¹ soil) 26.7±0.37 and soil organic carbon δ¹³C (‰) -26.7±0.02. In April 2009, twelve pots were sown with ryegrass (*Lolium perenne*) at 2000 grains m⁻² density while twelve were kept bare. All these planted and bare soil pots were placed in a mesocosm under ¹³C-depleted continuous labelling system for the whole duration of experiment. Automated

drip irrigation was used to maintain the soil moisture around $75 \pm 5\%$ of field capacity of the soil. All planted pots were fertilized with nitrogen (70 kg N ha^{-1}), phosphorus ($100 \text{ kg P}_2\text{O}_5 \text{ ha}^{-1}$) and potassium ($200 \text{ kg K}_2\text{O ha}^{-1}$) after their first clipping carried out 122 days after their germination. Two other clippings were carried out 210 and 319 days after germination.

V.2. Labelling system & mesocosm

The scheme of experimental set-up is shown in Supplementary material I. It consisted of two parts: a labelling air production system and a mesocosm containing planted and bare pots. Details on production of labelled air are available in Supplementary Information. Briefly, ambient air was taken into the system by a compressor and its CO_2 and H_2O contents and all other particles were scrubbed by a molecular sieve. The decarbonised air was then mixed with ^{13}C depleted CO_2 of fossil-fuel origin ($\delta^{13}\text{C}$: $-38.55 \pm 0.07 \text{ ‰}$) and conducted through a humidifier ($1\text{m}^3:1\text{m}^2$ cross corrugated cellulose pads). The water flow in the humidifier was regulated such that the relative humidity of labelled air reaching to mesocosm was maintained around 50-60%. This moistened air had CO_2 concentration of $400 \pm 20 \text{ ppm}$ before entering into mesocosm.

The mesocosm was made-up of an iron box with a plexiglass mounted on it. It had dimensions of $350 \times 140 \times 140 \text{ cm}$. The advantage of using plexiglass is that it does not change the wavelength of sunlight entering into mesocosm. All planted and bare soil pots were placed in mesocosm that was continuously ventilated with air produced by the labelling system. The volume of air in mesocosm was renewed twice a minute so that the unlabelled air respired by soil did not change the labelling signature of air present in the mesocosm. We verified with a smoke apparatus that turbulences in mesocosm were sufficient to ensure the mixing of air. The ventilation of mesocosm also allowed keeping a temperature difference to $1\text{-}2^\circ\text{C}$ between inside and outside of mesocosm.

The labelling of whole plants with ^{13}C depleted CO_2 was successful. The measured $\delta^{13}\text{C}$ label of shoots and roots were statistically similar and amounted $-56.83 \pm 0.20\%$ and $-57.75 \pm 0.14\%$ for shoots and roots respectively.

V.3. Respiration measurement

We waited for 155 days before taking the first respiration measure to permit the plants to colonize the entire soil present in the pot. For respiration measurements, pots were taken out from labelling mesocosm and were sealed in air-tight PVC chambers (height 100 cm, diameter 15 cm) for 24 hrs. The absence of light stopped photosynthesis and avoided the plant absorption of soil respired CO_2 . Carbon dioxide released by the plant-soil system was trapped in 200 ml of 1M NaOH that was placed in respiration chambers. By conducting additional measurement on respiration chambers by gas chromatography, we quantified that more than 99% of CO_2 respired by the pot (soil + plant) over 24 hours was trapped successfully into NaOH. Total carbon trapped in NaOH was measured with a total inorganic-C analyzer. The ^{13}C abundance of trapped CO_2 was analysed with an Isotope-Ratio Mass Spectrometer (IRMS) after precipitating the carbonates with excess BaCl_2 and filtration. The recalcitrant soil C-derived $\text{CO}_2\text{-C}$ (R_r , $\text{mg CO}_2\text{-C kg}^{-1}$ dry soil day^{-1}) was separated from plant-derived fresh $\text{CO}_2\text{-C}$ (R_f , $\text{mg CO}_2\text{-C kg}^{-1}$ dry soil day^{-1}) using mass balance equations:

$$R_r + R_f = R_t$$

$$R_r \times A_r^{13} + R_f \times A_f^{13} = R_t \times A_t^{13} \quad (12)$$

where R_r is flux of respiration from recalcitrant soil C ($\text{mg CO}_2\text{-C kg}^{-1}$ soil day^{-1}) corresponding to V_{max} in our model, R_f is flux of fresh C ($\text{mg CO}_2\text{-C kg}^{-1}$ soil day^{-1}) respired by soil-plant system corresponding to Φ_f in our model and R_t is sum of these fluxes. A_r^{13} , A_f^{13} and A_t^{13} are ^{13}C isotopic abundances of soil C, plant C and total CO_2 respired from soil-plant system respectively.

V.4. Statistical analysis

To test the effect of plant presence on the mineralization of recalcitrant soil organic C (R_r), we applied a repeated measures ANOVA on R_r with 'date of measurement' as a random factor and 'plant cover' as fixed factor. Linear regression was applied to determine the correlation between fresh C flux from soil-plant system (Φ_f) and mineralization of recalcitrant soil organic C (R_r). Repeated measures ANOVA were used to determine the effect of temperature on fresh C flux (Φ_f) from plant-soil systems and recalcitrant soil organic C mineralization from bare soils. Similarly, a repeated measures ANOVA was used to determine the effect of temperature on recalcitrant soil organic C mineralization from planted soils (with and without normalization with fresh C flux). The equation predicting the effect of temperature on a steady-state system (Eq. 11) was log transformed before fitting to experimental data. All statistical analyses were realized with Statgraphics Plus (Manugistics, USA).

VI. Results

VI.1. Effect of plant on soil respiration

The presence of *Lolium perenne* plants significantly increased the mineralization of recalcitrant soil C throughout experiment (Figure 3a, p -value = 0.000). The increase in mineralization of recalcitrant soil C represented on the average 202 % of that in bare soils. Consistent our Eq. 2, the mineralization of recalcitrant soil C was linearly related with fresh C respired by soil-plant system for a given temperature (Figure 3b). This energy dependence of mineralization of recalcitrant soil C is also supported by an independent incubation experiment on the same soil (Supplementary material II).

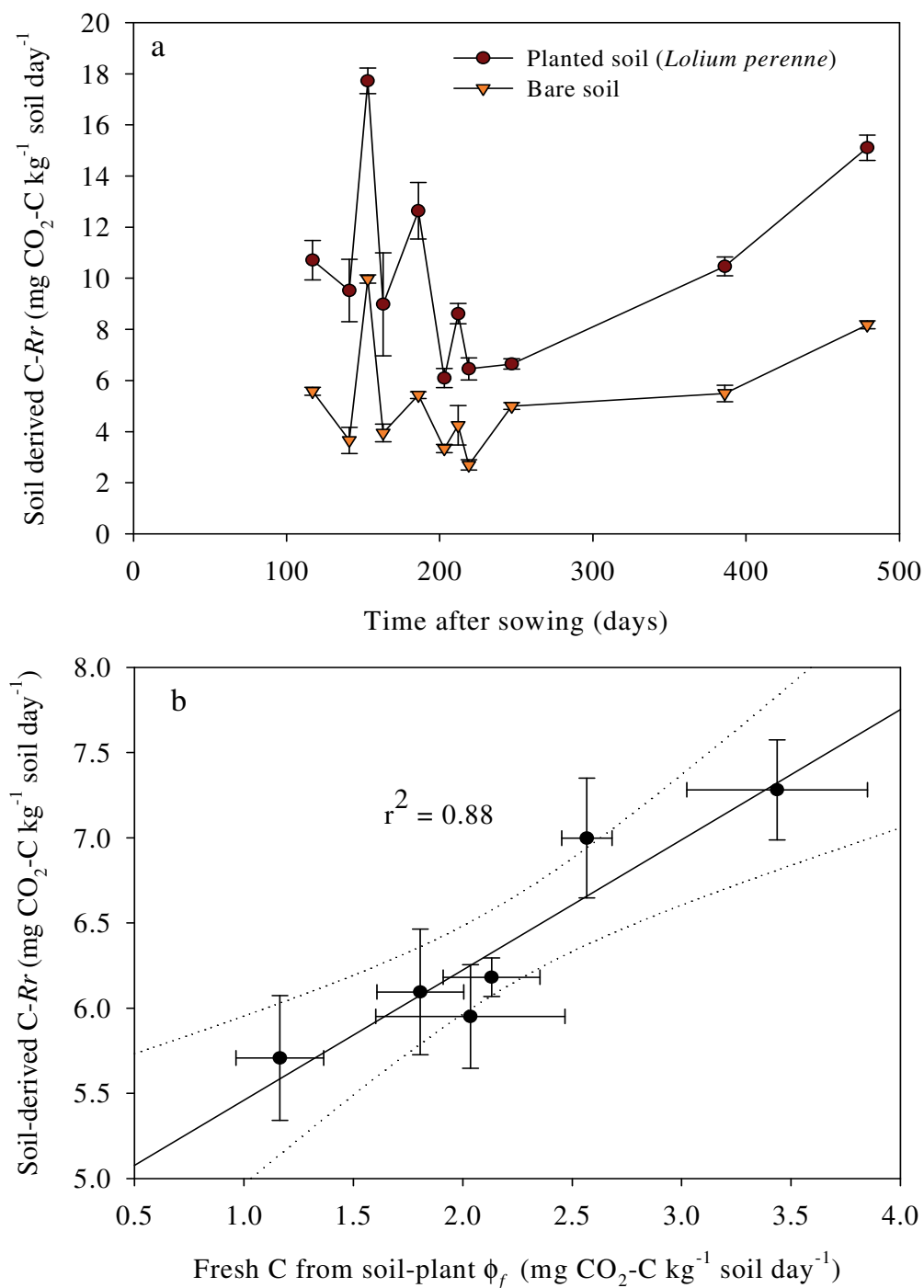

Figure 3. (a) Recalcitrant soil C mineralization (mg CO₂-C kg⁻¹ soil day⁻¹) in control and planted (*Lolium perenne*) soils (b) relationship between fresh C and recalcitrant soil C mineralizations (mg CO₂-C kg⁻¹ soil day⁻¹) in soil-plant system at mean daily temperature of 285 °C.

VI.2. Effect of temperature on fresh C respiration

The fresh C respiration by soil-plant system, *Lolium perenne*, increased significantly with seasonal increase in temperature (Figure 4, p -value = 0.000). Seasonal increase in temperature favours the plant photosynthesis hence the fresh C supply into soil is increased as shown by higher amounts of particulate organic matter present in soil (data not shown). Since the mineralization of recalcitrant C is determined by the fresh C respiration (Figure 3b), the recalcitrant soil C mineralization must be expressed per unit of fresh C respired by soil-plant system in order to determine the effect of temperature (Eq. 11).

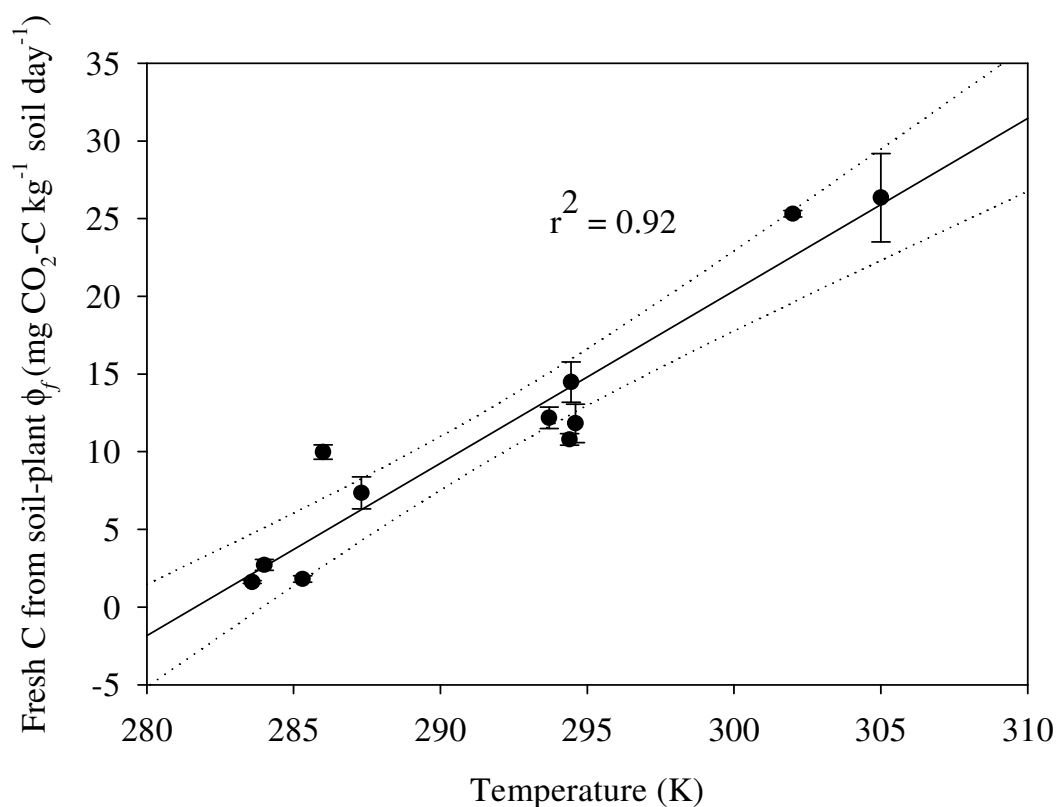

Figure 4. Effect of seasonal temperature (K) on the respiration of fresh C on the respiration of fresh C (¹³C-labelled) flux (mg CO₂-C kg⁻¹ soil day⁻¹) from soil-plant system of *Lolium perenne*.

VI.3. Testing the theory: effect of temperature on recalcitrant C mineralization in planted and bare soils

As predicted by our theory for non-steady-state system, the mineralization of recalcitrant soil C in bare soils increased with temperature (Figure 5, p -value = 0.000). It is interesting to note that the range of temperatures faced by our experiment did not include the optimum temperature for enzymes mineralizing recalcitrant soil C in our ecosystem.

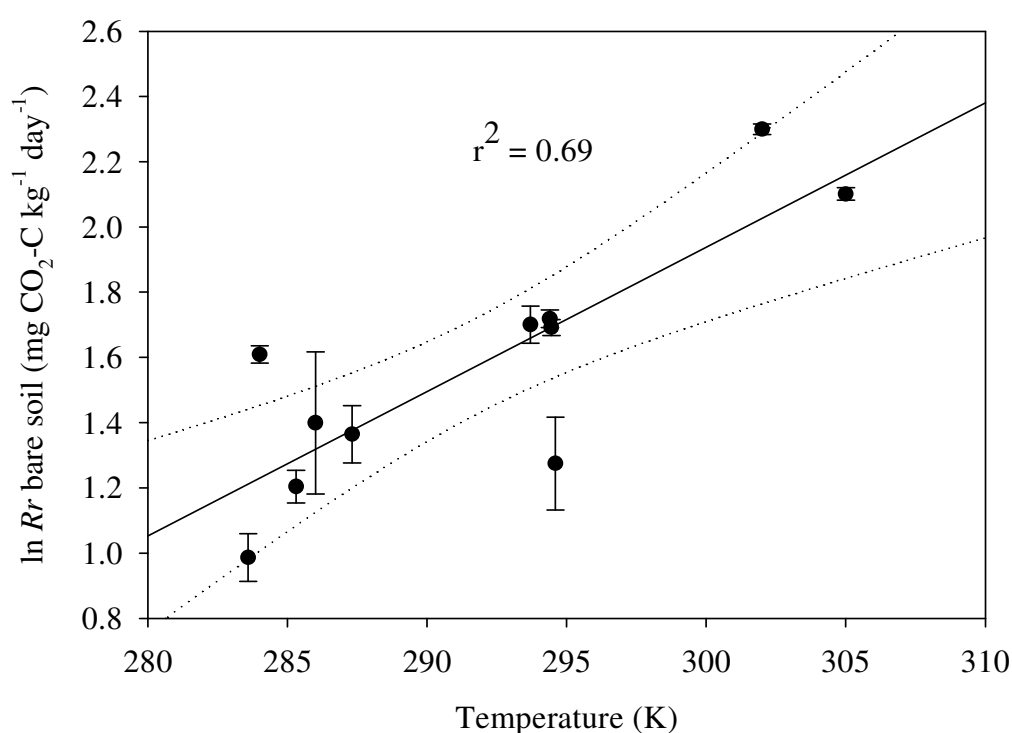

Figure 5. The response of recalcitrant soil C mineralization ($\text{mg CO}_2\text{-C kg}^{-1} \text{ soil day}^{-1}$) in bare soils to seasonal temperature.

When the increase in fresh C flux with seasonal temperature is not taken into account, the mineralization of recalcitrant soil C significantly increased with seasonal temperature in the soil-plant system of *Lolium perenne* (Figure 6, p -value = 0.000). However, after normalization with fresh C flux according to Eq. (11), temperature negatively affects the mineralization of recalcitrant soil C (Figure 7a). Moreover, this negative effect of temperature on recalcitrant soil C mineralization was common to the six other grassland species used to

generalize results (Figure 7b). Therefore, the experimental results confirm the model prediction that temperature and recalcitrant soil mineralization are negatively linked in steady-state soil-plant system.

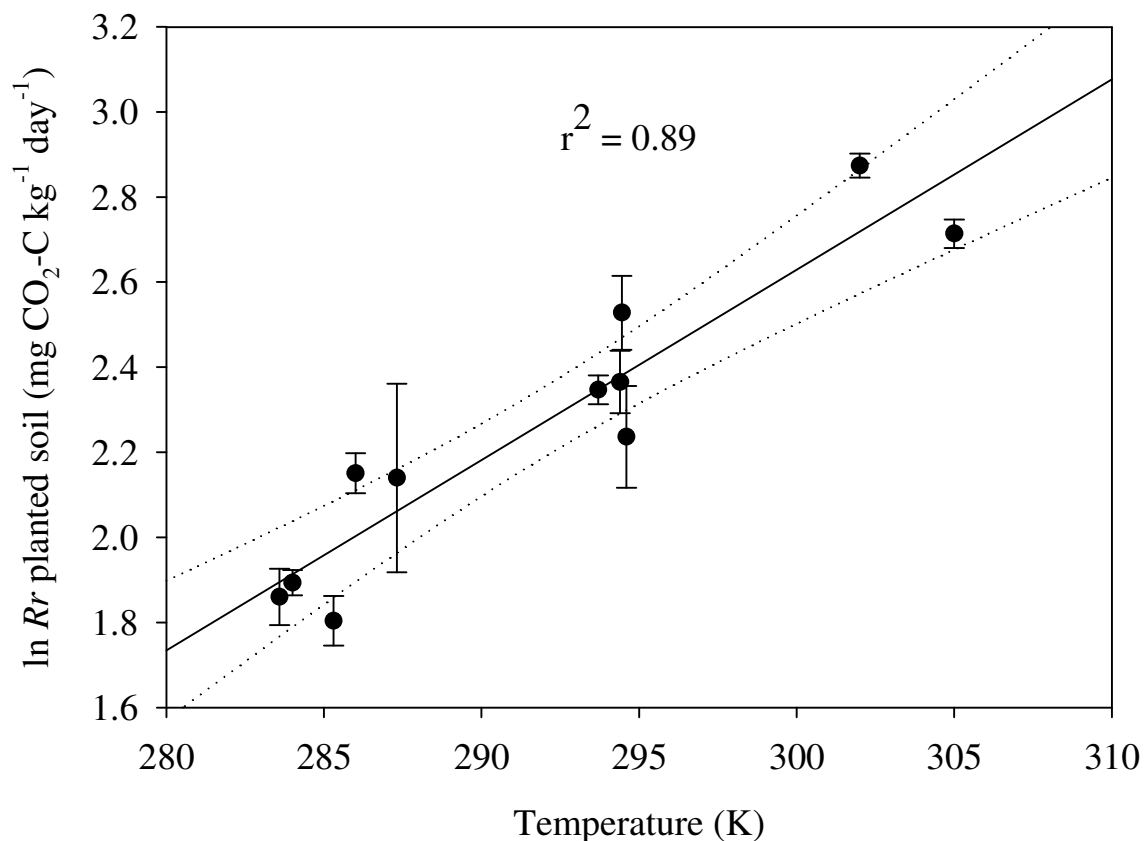

Figure 6. The response of recalcitrant soil C mineralization Rr ($\text{mg CO}_2\text{-C kg}^{-1} \text{ soil day}^{-1}$) in planted soils (*Lolium perenne*) to seasonal temperature variation when fresh C flux is not taken into account.

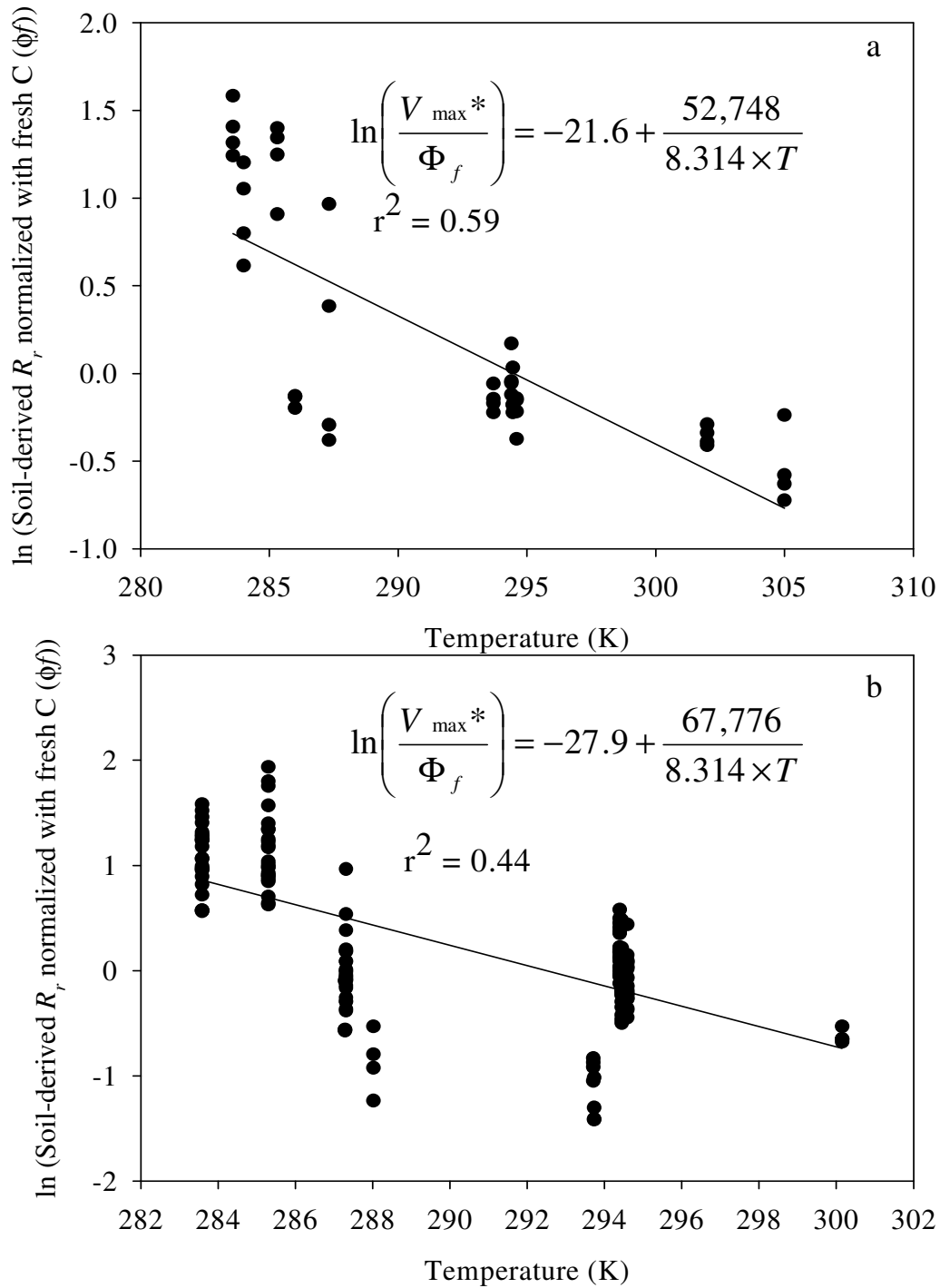

Figure 7. Experimental validation of the theory predicting negative effect of temperature (K) on recalcitrant soil C mineralization in steady-state system (V_{\max}^*). Results show that the mineralization of recalcitrant soil C decrease with warming in the plant-soil systems of (a) the model species *Lolium perenne* and (b) six other grassland species used to generalize findings, i.e. *Trisetum flavescens*, *Poa trivialis*, *Festuca arundinacea*, *Bromus erectus*, *Brachypodium pinnatum* and *Trifolium repens*. The rate of recalcitrant C mineralization is normalized with the flux of fresh C (Φ_f) and adjusted with linearized form of Eq. 9 i.e.

$$\ln\left(\frac{v_{\max}^*}{\Phi_f}\right) = \ln(\omega) + \frac{\Delta EA}{RT}.$$

VII. Conclusion

Our findings show that, when the temperature-dependent inactivation of enzymes and the energy limitation of microbial decomposers are considered explicitly in models, the prediction regarding the effect of temperature on soil C mineralization is not as simple as suggested by the Arrhenius equation. In contrast to the prediction of Arrhenius's equation, our results show that the temperature negatively affects the mineralization rate of recalcitrant soil C when the flux of fresh C supplying soil microbes in energy is taken into account. Our model indicates that this negative temperature effect arises from an intensification of enzyme inactivation when temperature increases. These results can explain why long-term soil warming in field experiment does not induce loss of soil organic matter (Melillo et al., 2002; Eliasson et al., 2005) as predicted by Arrhenius equation. These results also concur with the fact that the annual net ecosystem productivity (i.e. annual C fixation by ecosystem) of ecosystems is positively related with the annual mean temperature (Sanderman et al., 2003). Overall, our results also suggest that the increase in mean temperature at global scale due to the global warming will not necessary induce the large losses of soil C predicted by current models (Jones et al., 2004). It is important to mention here that our predictions do not apply for arctic ecosystems where the frost blocks the diffusion of substrates and enzymes and hence the soil carbon mineralization most of the year. In these ecosystems, an increase in temperature will probably induce the mineralization of large reserve of fresh un-decomposed plant litter (Jorgenson et al., 2006).

Our results show a linear positive relationship between the respiration of fresh C by the soil plant system and the mineralization rate of recalcitrant soil C. These results are coherent with the idea that soil decomposers degrade recalcitrant soil C compounds through a co-metabolism using fresh plant-derived C as a source of available energy (Bingeman et al.,

1953; Kuzyakov 2000). Interestingly, our results show that the increase in temperature and respiration of fresh C is concomitant in ecosystems. This concomitance is likely due to the fact that the elevation of temperature follows the solar activity which in turn determines the photosynthetic fixation of carbon and hence the availability of fresh C in the soil-plant system. Therefore, in order to determine the specific effect of temperature on recalcitrant soil C mineralization the latter must be expressed per unit of fresh C respired by the soil-plant system. This separation of the effect of fresh C and temperature increase is also important to predict the consequence of global warming on ecosystem C storage. Indeed, contrary to temperature increase, the supply of fresh C to soil microbes not only stimulates mineralization of pre-existent recalcitrant soil C but also permits the formation of new recalcitrant C through humification of fresh C.

Historical lab experiments demonstrated a rule of thumb widely accepted in the biological research community i.e. the rate of soil C respiration, like any other enzymatic reaction rate, tends to double for every 10° rise in temperature. On this basis, it has been proposed to use the Arrhenius equation in plant-soil models in order to introduce the thermo-dependence of enzymatic reactions and predict the response of the ecosystem fluxes to global warming. However, our results support the idea that such extrapolation of lab experiment results to ecosystem functioning is an error. Indeed, warming not only increases the specific activity of enzymes (k_{cat}) but also the inactivation rate of enzymes (k_{inact}). In short-term incubation experiment (Eq 6, $\text{time} \rightarrow 0$), the amount of inactivated enzymes remains low and hence the temperature response of the global enzymatic activity ($V_{max\ ns}(t)$) is mainly determined by the increase of the specific activity of enzymes (k_{cat}). In this case, our model predicts a positive relationship between temperature and the global catalytic activity until an optimum temperature beyond which the rate of enzyme inactivation (k_{inact}) becomes so high that the catalytic activity decreases (Eq 6, Fig 1). The fact that these optimum temperatures

are rarely reached in ecosystems probably explains why classical models do not represent enzyme inactivation process (McGill, 1996). In ecosystems, simultaneous microbial production of new enzymes and thermo-dependent enzyme inactivation determine the pool of active enzymes and hence the mineralization of recalcitrant C (Eqs. 7 & 8). In this case, our model predicts that the temperature response of recalcitrant soil C mineralization is determined by the relative response of catalytic activity (k_{cat}) and enzyme inactivation (k_{inact}) to temperature (Eqs. 8 and 9). Since the inactivation of enzymes is typically more thermo-sensible than the catalytic activity of enzymes, our model predicts that the temperature should negatively affect the rate of SOM mineralization which is supported by our experimental results.

Our theory has some limitations as well. It does not take into account the microbial physiology in response to temperature. Complex models involving microbes are needed to take into account the physiological functioning of microbes in response to varying temperatures. For a system at equilibrium (an ecosystem), our model predicts negative effect of temperature on recalcitrant soil C mineralization after taking into account enzyme inactivation and flux of fresh C input. The next step would be to measure inactivation and catalysis constants at equilibrium for the enzymes extracted from soil.

Acknowledgment:

We thank S. Revaillet, O. Delfosse and J.-L. Ollier for chemical and isotopic analyses. Maurice Crocombette and Patrick Pichon are thanked for their mesocosm construction and experiment establishment respectively. The research leading to these results has received funding from the European Community's 6th and 7th Framework Programs (FP6 and FP7) under grant agreement n° 017841 (Nitro-Europe) and n° 226701 (CARBO-Extreme). TS has

been funded by Higher Education Commission of Pakistan and European Community's 7th framework under grant agreement n° 226701 (CARBO-EXTREME).

VIII. References

- Arrhenius, S. 1889. Über die Reaktionsgeschwindigkeit bei der Inversion von Rohrzucker durch Säuren. *Zeitschrift fuer physikalische Chemie* 4, 226-248.
- Bingeman, C.W., Varner, J.E., Martin, W.P., 1953. The effect of the addition of organic materials on the decomposition of an organic soil. *Soil Science Society of America Journal*. 17, 34-38.
- Blagodatskaya, E., Kuzyakov, Y., 2008. Mechanisms of real and apparent priming effects and their dependence on soil microbial biomass and community structure: critical review. *Biology and Fertility of Soils* 45, 115-131.
- Copeland, R.A., 2000. *Enzymes: A practical introduction to structure, mechanism and data analysis*, Wiley-VCH.
- Daniel, R.M., Danson, M.J., 2010. A new understanding of how temperature affects the catalytic activity of enzymes. *Trends in Biochemical Sciences* 35, 584-591.
- Eliasson, P.E., McMurtrie, R.E., Pepper, D.A., Strömgren, M., Linder, S., Ågren, G.I., 2005. The response of heterotrophic CO₂ flux to soil warming. *Global Change Biology* 11, 167-181.
- Eyring, H., 1935. The Activated Complex in Chemical Reactions. *The Journal of Chemical Physics* 3, 107-115.
- Fontaine, S., Barot, S., 2005. Size and functional diversity of microbe populations control plant persistence and long-term soil carbon accumulation. *Ecology Letters* 8, 1075-1087.
- Fontaine, S., Barot, S., Barre, P., Bdioui, N., Mary, B., Rumpel, C., 2007. Stability of organic carbon in deep soil layers controlled by fresh carbon supply. *Nature* 450, 277-280.
- Giardina, C.P., Ryan, M.G., 2000. Evidence that decomposition rates of organic carbon in mineral soil do not vary with temperature. *Nature* 404, 858-861.

- Guenet, B., Danger, M., Abbadie, L., Lacroix, G., 2010. Priming effect: bridging the gap between terrestrial and aquatic ecology. *Ecology* 91, 2850-2861.
- Jones, C., McConnell, C., Coleman, K., Cox, P., Falloon, P., Jenkinson, D., Powlson, D., 2005. Global climate change and soil carbon stocks; predictions from two contrasting models for the turnover of organic carbon in soil. *Global Change Biology* 11, 154-166.
- Jorgenson, M.T., Shur, Y.L., Pullman, E.R., 2006. Abrupt increase in permafrost degradation in Arctic Alaska. *Geophys. Res. Lett.* 33, L02503.
- Kirschbaum, M.U.F., 1995. The temperature dependence of soil organic matter decomposition, and the effect of global warming on soil organic C storage. *Soil Biology and Biochemistry* 27, 753-760.
- Knorr, W., Prentice, I.C., House, J.I., Holland, E.A., 2005. Long-term sensitivity of soil carbon turnover to warming. *Nature* 433, 298-301.
- Kuzyakov, Y., Friedel, J.K., Stahr, K., 2000. Review of mechanisms and quantification of priming effects. *Soil Biology & Biochemistry* 32, 1485-1498.
- Lloyd, J., Taylor, J.A., 1994. On the temperature dependence of soil respiration. *Functional ecology*. 8, 315-323.
- Massey, V., Curti, B., Ganther, H., 1966. A Temperature-dependent conformational change in d-amino acid oxidase and Its Effect on catalysis. *Journal of Biological Chemistry* 241, 2347-2357.
- Melillo, J.M., Steudler, P.A., Aber, J.D., Newkirk, K., Lux, H., Bowles, F.P., Catricala, C., Magill, A., Ahrens, T., Morrisseau, S., 2002. Soil warming and carbon-cycle feedbacks to the climate system. *Science* 298, 2173-2176.
- Paul, E.A., Clark, F.E., 1989. *Soil microbiology and biochemistry*. Academic Press, USA.

- Peterson, M.E., Daniel, R.M., Danson, M.J., Eisenthal, R., 2007. The dependence of enzyme activity on temperature: determination and validation of parameters. *Biochemical Journal* 402, 331-337.
- Pilegaard, K., Hummelshøj, P., Jensen, N.O., Chen, Z., 2001. Two years of continuous CO₂ eddy-flux measurements over a Danish beech forest. *Agricultural and Forest Meteorology* 107, 29-41.
- Sanderman, J., Amundson, R.G., Baldocchi, D.D., 2003. Application of eddy covariance measurements to the temperature dependence of soil organic matter mean residence time. *Global Biogeochemical Cycles* 17.
- Thierron, V., Laudelout, H., 1996. Contribution of root respiration to total CO₂ efflux from the soil of a deciduous forest. *Canadian Journal of Forest Research-Revue Canadienne De Recherche Forestiere* 26, 1142-1148.
- Waldrop, M.P., Firestone, M.K., 2004. Altered utilization patterns of young and old soil C by microorganisms caused by temperature shifts and N additions. *Biogeochemistry* 67, 235-248.

Enzyme inactivation and microbial energy limitation explain negative temperature response of recalcitrant soil carbon decomposition in steady state soil-plant systems

Supplementary Material I:

Labelling System:

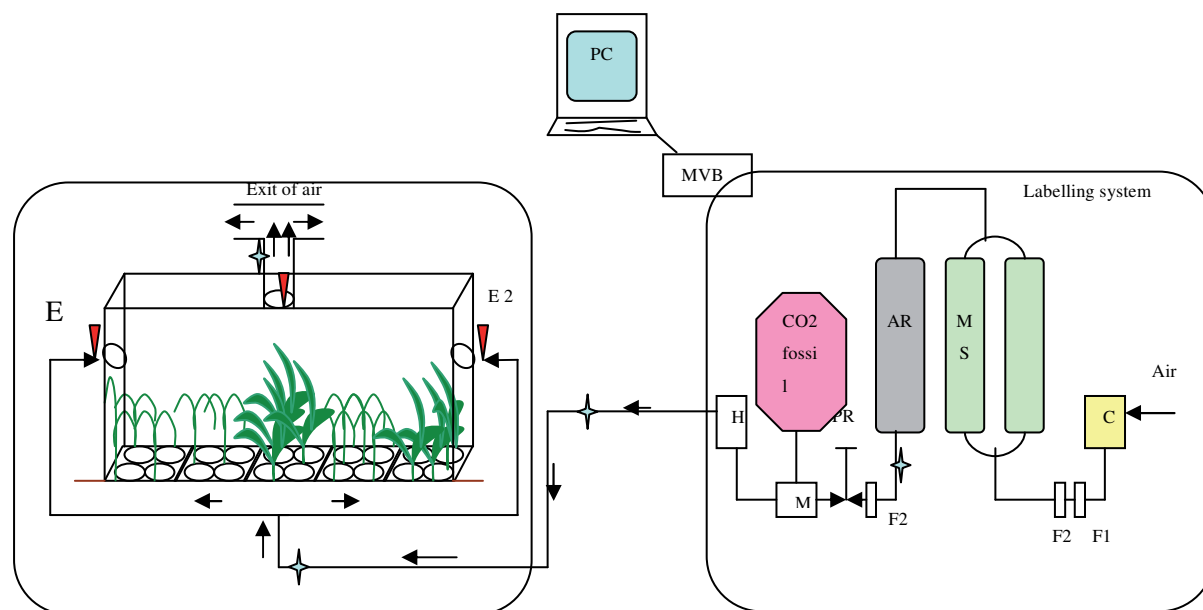

C Compressor: MS, Molecular sieve: AR, Air reservoir: F1, oil & water extraction: F2, oil, water & particle filter:

PR, Pressure regulator: MFC, mass flow controller: HF, Humidifier: MVB, Multivalve block: E1 & E2, Air entrances:

Figure 1. The scheme of labelling system and mesocosm.

Production of decarbonised air:

Ambient air was taken into the system by a compressor, its CO₂ and H₂O contents and all other particles were scrubbed by a molecular sieve and once this decarbonised air is in

distribution tube ^{13}C depleted CO_2 of fossil-fuel origin was mixed with it. A screw compressor, a self-regenerating adsorption dryer capable of generating decarbonised air at a rate of up to 5000 standard litres per minute (SLPM) and residual CO_2 below $1\ \mu\text{mol CO}_2\ \text{mol}^{-1}$ air, an air reservoir, gas cylinders containing fossil fuel derived CO_2 and a humidifier ($1\text{m}^3:1\text{m}^2$ cross corrugated cellulose pads) constitute the main parts of the labelling system. A mass flow meter served to control the CO_2 injection rate and flow rate of the whole system was controlled by pressure regulators. During daytime, around 30 % of decarbonised dry was diverted to adsorber chamber to regenerate the molecular sieve of adsorption. Therein, drying and regeneration alternated in six minute cycles. There was no supply of decarbonised air during night (from one hour after sunset till one hour before sunrise) which permitted a full regeneration of the adsorption dryer cycles.

Supplementary Material II:

TESTING THE RELATIONSHIP BETWEEN PRIMING EFFECT AND FRESH ORGANIC MATTER SUBSTRATE

A number of studies have shown that soil organic matter (SOM) decomposition is accelerated after the introduction of fresh organic matter like glucose, cellulose or plant litter (see Blagodatskaya & Kuzyakov 2008 for a review). This acceleration of SOM decomposition is known as priming effect (PE) and can be explained mechanistically according to a co-limitation theory (Fontaine et al. 2011). Micro-organisms, which are co-limited by energy and by nutrients, used this fresh substrate as a source of energy to produce enzymes that are able to degrade recalcitrant SOM, rich in nutrients. However, if the PE mechanism begins to be well studied, little is known about the relationship which links PE intensity with the provided quantity of substrate or the biomass of microbes that is stimulated by this substrate. Is this relationship linear or more complex with a saturation phenomenon, as suggested by modeling studies (Wutzler & Reichstein 2008)?

An incubation experiment was conducted testing the intensity of PE induced by varying the initial mass of fresh organic matter. In our experiment, cellulose was chosen as fresh organic matter, limiting the apparent priming effect (turnover of microbial tissue,

Blagodatskaya & Kuzyakov 2008) mainly observed with glucose and simplifying result interpretation in comparison with plant litter.

Experimental units consisted of 58.5 g (oven-dried basis) samples of fresh sieved soil placed in 500 ml flasks and incubated at 20°C for 177 days. After 15 days of pre-incubation, four doses (0, 1, 3 and 6 g C-cellulose kg⁻¹ soil) of dual-labeled cellulose ($\delta^{13}\text{C} = 2.87 \text{ ‰}$) were added to the incubated soil samples and mixed with the soil. Cellulose was extracted according to the method described by Wise (1944) from residue of flax, which has grown in ¹³CO₂ enriched atmosphere. A nutrient solution (NH₄NO₃, KH₂PO₄) was applied to soil to give final C-cellulose:N and C-cellulose:P ratios of 15:1 and 80:1, meaning that cellulolytic micro-organisms were not limited by nutrients (e.g. Hodge *et al.* 2000). The moisture content of the soil was adjusted to obtain a water potential of -100 kPa. The CO₂ released was trapped in NaOH solution and was measured with a total inorganic-C analyzer. The NaOH solution was replaced when the concentration of CO₂ in flasks, measured in a separate set, approached 2-3%. The flasks were flushed with CO₂-free air at each replacement of NaOH solution. The ¹³C abundance of CO₂ was analyzed by an elemental analyzer coupled to a mass spectrometer after precipitating the carbonates with excess BaCl₂ and filtration. Destructive sampling was performed at day 0, 20, 40, 80, 160 and 320 to assess microbial biomass (Vance *et al.* 1987).

Figures 1 show linear relationships between the initial quantity of cellulose supplied to soil and PE (Fig. 1A) as well as between the peak of microbial biomass (BM) and PE (Fig. 1B). Other relationships were tested but fit with less accuracy than the linear relationship to measured data. For example, with the same number of parameter, the second best relationships fitting observations are square relationships ($Y = a + b\sqrt{X}$, $r^2 = 0.93$, $P < 0.05$ between cellulose and PE; and $Y = (a + b\sqrt{X})^2$, $r^2 = 0.91$, $P < 0.05$ between BM and PE). The intercept of the linear relationships were both not different from zero, indicating that PE did not occurred without fresh organic matter or without microbes.

The linearity of these relationships has been important to demonstrate both for using statistical test which often required linearity between variables and for modeling the functioning of soil.

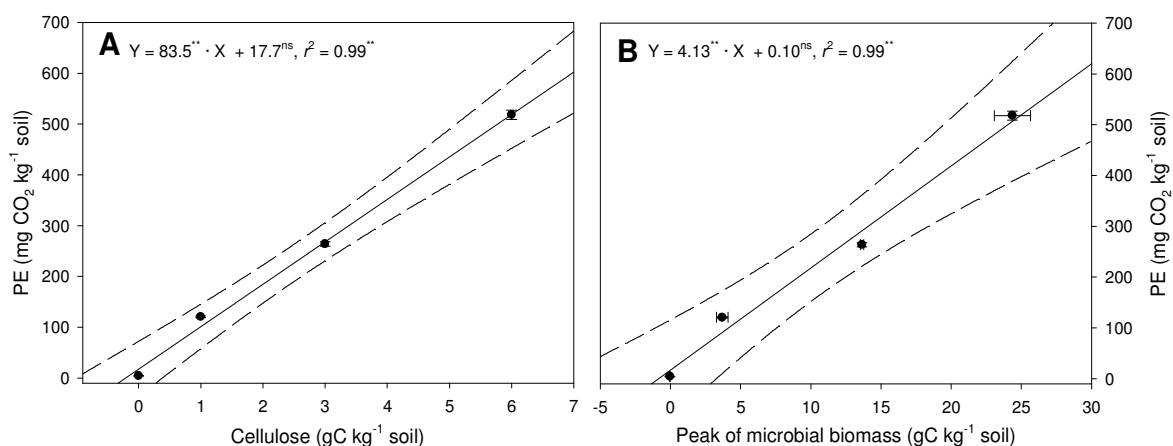

Figure 1: Relationships between soil microbial biomass (BM) at the peak of BM (40th day) (A), initial quantity of cellulose (B) and cumulative CO₂ flux of mineralized MOS (PE, priming-effect) throughout the 177 days of soil incubation. The incubated soil is a Cambisol sampled in 2007 in Theix on the horizon 40-60cm.

References

- Blagodatskaya, E., Kuzyakov, Y., 2008. Mechanisms of real and apparent priming effects and their dependence on soil microbial biomass and community structure: critical review. *Biology and Fertility of Soils* 45, 115-131.
- Fontaine, S., Henault, C., Aamor, A., Bdioui, N., Bloor, J.M.G., Maire, V., Mary, B., Revalliot, S., Maron, P.A., 2011. Fungi mediate long term sequestration of carbon and nitrogen in soil through their priming effect. *Soil Biology & Biochemistry* 43, 86-96.
- Vance, E. D., Brookes, P. C., Jenkinson, D.S., 1987. An extraction method for measuring soil microbial biomass C. *Soil Biology & Biochemistry* 19, 703-707.
- Wise, L.E., 1944. *Wood chemistry*. Reinhold, Seattle, USA.
- Wutzler, T., Reichstein, M., 2008. Colimitation of decomposition by substrate and decomposers - a comparison of model formulations. *Biogeosciences* 5, 749-759.

CHAPTER 5

Articles in Preparation

ARTICLES IN PREPARATION

In addition to the three experiments discussed in detail in the form of finished articles in previous chapters (2 to 4), we tested three other hypotheses. However, we do not have complete data available at present for these experiments. That is why; the preliminary results that were available have been assembled in this chapter and are presented below as three parts of the current chapter:

PART 1: THE EFFECT OF SIX GRAMINEAE AND ONE LEGUMINOUS SPECIES ON SOIL ORGANIC MATTER DYNAMICS IN TEMPERATE GRASSLAND

Differences among and changes in plant communities have been shown to affect soil organic matter pools and dynamics through inter-specific differences in rhizodeposition of labile C compounds (Fu and Cheng et al., 2002; Cheng et al., 2003; Dijkstra et al., 2006). Similarly inter-specific differences in root litter and labile C production through rhizodeposition play an important role in soil N dynamics (Wedin and Tilman 1990; Eviner 2004). Moreover, plant species have been shown to differ in terms of duration for which to retain mineral N in their biomass by controlling the amount of C inputs into soil (and hence N in biomass) i.e. conservative, tall statured and exploitative, short statured plants (Personeni and Loiseau 2005). The plants are thus susceptible to affect the soil organic matter (SOM) processes by two ways: by controlling the amount and chemistry of C inputs in soil and by imposing a certain N balance in soil through N uptake and its return in soil (*via* C input). These two mechanisms by which plants can affect organic C processes not clear to date.

To determine the effect of varying amounts of C inputs of different qualities and N balance induced by grassland plants, we selected six gramineae species i.e. *Trisetum*

flavescens (Tf), *Poa trivialis* (Pt), *Lolium perenne* (Lp), *Festuca arundinacea* (Fa), *Bromus erectus* (Be) and *Brachypodium pinnatum* (Bp). A leguminous species i.e. *Trifolium repens* (Tr) that can fix atmospheric N and thus impose positive or the least negative N balance in soil was also included in the experiment. It was hypothesized that the plants depositing higher amounts of fresh C will induce higher mineralization of SOC and more C will be stocked under the plants which impose least negative N balance in soil. All the plants were grown in monocultures in pots whereas bare soils were used as controls. The planted and bare pots were placed in a mesocosm for continuous ^{13}C labelling for whole duration of experiment. The continuous ^{13}C labelling allowed distinguishing soil-derived CO_2 efflux from plant-derived CO_2 one. The respiration measures were carried out for planted as well as bare soils using the method described earlier (Chapter 1). After 120 days of sowing, one set of pots was destructively sampled for soil. Particulate organic matter (POM) fractions were separated with by passing the soil through a series of two brass sieves (wet sieving) of decreasing mesh sizes (1 mm and 200 μm). The remaining material in each sieve was separated into mineral and organic fraction by density flotation in water (Loiseau and Soussana 1999). The organic fraction remaining in 1 mm sieve was named as coarse POM and that remaining in 200 μm sieve was named as fine POM.

The presence of plants accelerated the SOM mineralization significantly i.e. rhizosphere priming effect (RPE, difference between SOM mineralization in planted and control soils) was induced (Figure 5.1). All the gramineae species induced ~ 2 times whereas the legume induced ~ 4 times the SOM mineralization as compared to that in control soil. The rhizosphere priming effect, when expressed per unit of fresh C respired from soil-plant system, varied across species and remained lowest for the legume (Figure 5.2). Fine and coarse POM contents were significantly highest in legume treatment (Figure 5.3).

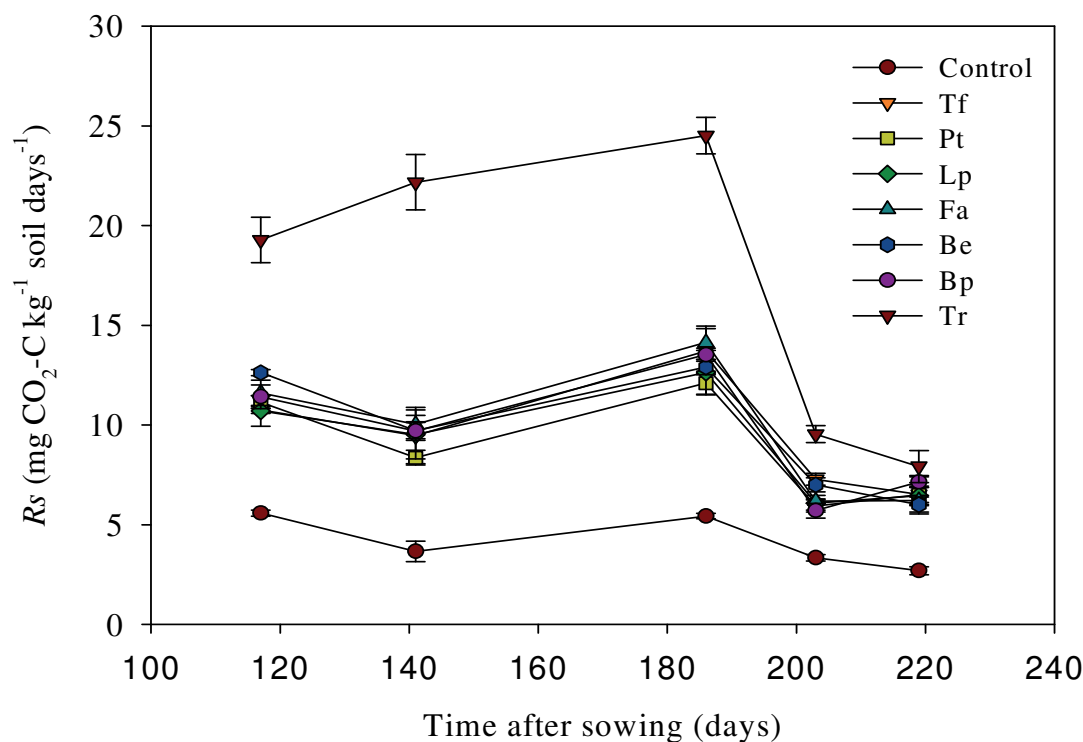

Figure 5.1. Dynamics of soil-derived CO₂ efflux (mg CO₂-C mg kg⁻¹ day⁻¹) from control and planted soils. Tf *Trisetum flavescens*, Pt *Poa trivialis*, Lp *Lolium perenne*, Fa *Festuca arundinacea*, Be *Bromus erectus*, Bp *Brachypodium pinnatum*, Tr *Trifolium repens*.

Our results show that all the plants involved in the study are capable of inducing RPE by supplying fresh C and stimulating soil microbes. A generalization can perhaps be made on the basis of this result that all the grassland plants can induce the acceleration of SOM mineralization. It is interesting to note that all the gramineae species induced similar rates of RPE despite varying in terms of rhizodeposition. Moreover, the legume plant induced the highest RPE whereas it was hypothesized to induce the lowest RPE owing to the positive or the least negative N balance in soil among species under study. However, when RPE was expressed per unit of fresh C respired from soil-plant system; an indicator of rhizodeposition, the legume plant induced the lowest amount of RPE. It suggests that the legume plant is inducing net storage of fresh C in soil. The gramineae species though inducing similar amounts of RPE vary in terms of RPE induced per unit of fresh C respired from soil-plant

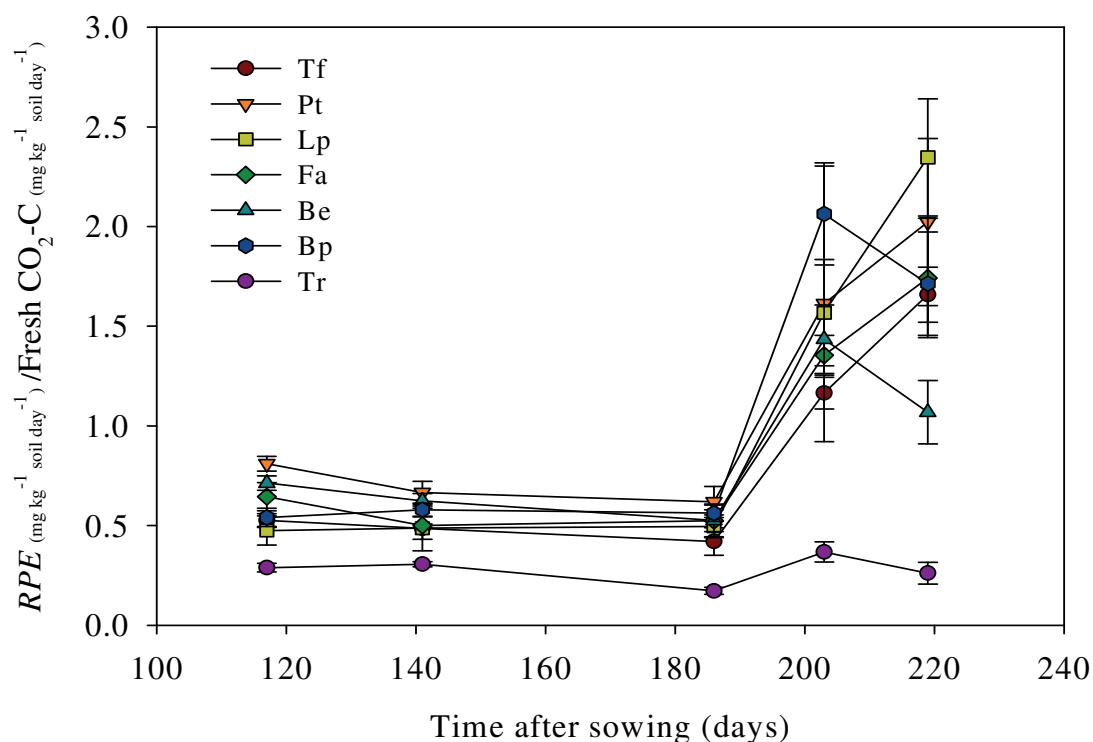

Figure 5.2. Rhizosphere priming effect ($\text{mg CO}_2\text{-C kg}^{-1} \text{ soil day}^{-1}$) expressed per unit of fresh C ($\text{mg CO}_2\text{-C kg}^{-1} \text{ soil day}^{-1}$) respired from soil-plant system.

system thereby suggesting various roles vis-à-vis SOM dynamics. The role of different grassland species on SOM dynamics will be better understood after complete analysis of net soil C balance and N assimilation by plants in relation to growth strategies of plant communities e.g. conservative and high statured versus exploitative and small statured plants.

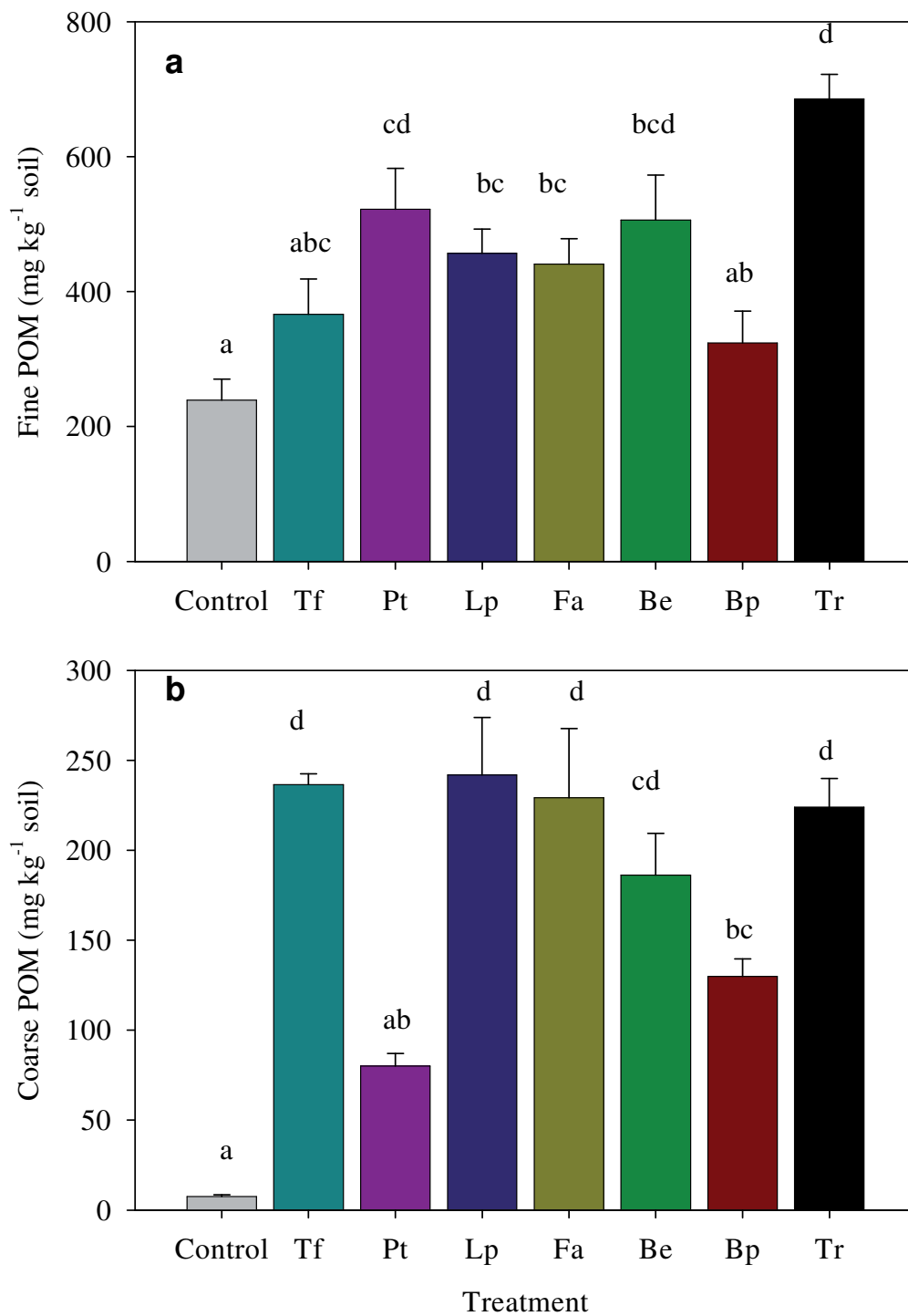

Figure 5.3. Fine particulate organic matter ($> 200 \mu\text{m}$) (a) and coarse particulate organic matter ($> 1 \text{mm}$) in control and planted soils 120 days after sowing (One-way ANOVA, $P < 0.05$, Tukey's HSD). Tf *Trisetum flavescens*, Pt *Poa trivialis*, Lp *Lolium perenne*, Fa *Festuca arundinacea*, Be *Bromus erectus*, Bp *Brachypodium pinnatum*, Tr *Trifolium repens*.

PART 2: DOES HIGHER AVAILABILITY OF N DECREASE SOIL ORGANIC C MINERALIZATION AND STORE MORE ORGANIC C?

A large percentage of the Earth's active carbon (C) is found in soil organic matter (SOM) and its cycling is strongly linked to nitrogen (N) availability. Although appreciation of the importance of soil C and N interactions for predicting the impacts of climate change has certainly increased, but we still lack full understanding and quantification of the drivers (Gruber and Galloway 2008).

It has been shown in lab conditions that in a fresh C amended soil, higher availability of mineral N decreases soil organic matter (SOM) mineralization as well as increases storage of the added C (fresh C) (Fontaine et al., 2004). The authors suggested that the decreased SOC mineralization under high fertility conditions after the addition of fresh C can be explained by competition between microbial groups for N. They suggested that under higher availability of N fresh organic matter (FOM) decomposers could fully express their rapid growth potential by using fresh C thereby surpassing the SOC decomposers who, unlike FOM decomposers, can mineralize SOM to acquire mineral nutrients under low N availability after supply of fresh C. It is not clear yet whether the N supply to a living plant would check the otherwise accelerated SOC mineralization because plant itself is a competitor for N in addition to various microbial groups.

In order to determine the effect of varying direct supplies of mineral N and indirect supply *via* an N-fixing plant on SOM dynamics under living plants, we established *Lolium perenne* and *Trifolium repens* in pots in April 2009. *Lolium perenne* was either grown in monocultures with two supplies of mineral N (*Lp* N++, *Lp* N+ treatments) or in mixed culture with legume plant *Trifolium repens* (*Lp* + *Tr*) where it could benefit from N fixed by the legume. The legume was also grown in monoculture (*Tr*) as a control for mixed culture (*Lp* +

Tr). Bare soils were used as controls for planted soils. The *Lolium perenne* pots were supplied with N either at the rate of 120 kg N ha⁻¹ (*Lp* N++) or 70 kg N ha⁻¹ (*Lp* N+) 117 days after sowing. The planted and bare pots were placed in a mesocosm for continuous ¹³C labelling for whole duration of the experiment. The continuous ¹³C labelling allowed distinguishing soil-derived CO₂ efflux from plant-derived CO₂ one. The respiration measures were carried out for planted as well as bare soils using the method described earlier (Chapter 1). The difference between soil-derived CO₂-C from planted soils and soil respiration from bare soils was calculated as Rhizosphere priming effect (RPE).

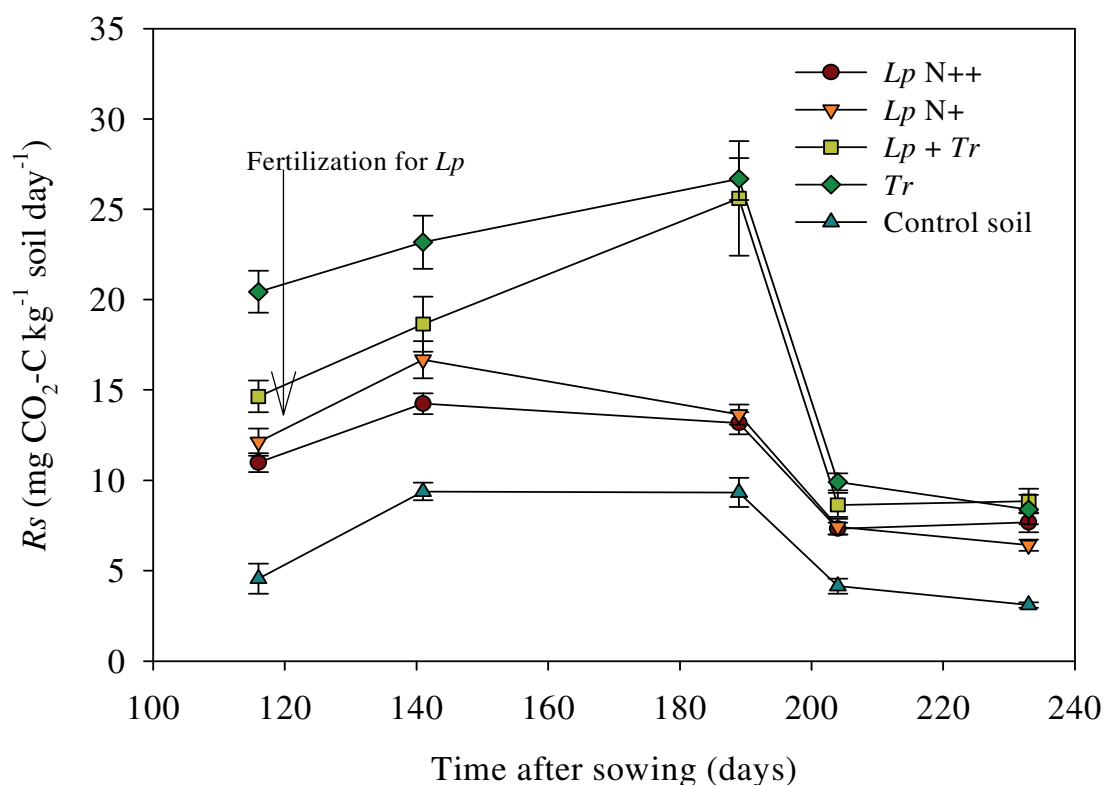

Figure 5.4. Soil-derived CO₂-C efflux, R_s (mg CO₂-C kg⁻¹ day⁻¹) from planted and control soils over the course of experiment. Error bars represent standard errors, n = 4).

The presence of plants significantly accelerated the SOM mineralization i.e. rhizosphere priming effect (*RPE*) was induced (Figure 5.4). For the first measure after fertilization (24 days after fertilization), *Lp* N+ treatment showed higher SOM mineralization

than *Lp* N++ treatment whereas *Lp* N++ treatment showed higher SOM mineralization for the last measure (237 days after sowing and 120 days after fertilization). The SOM mineralization in (*Lp* + *Tr*) and (*Tr*) where natural N was being fixed into the soil, remained higher than that in *Lp* monocultures for first three measures before showing similar rates. The RPE when expressed per unit of fresh C respired from soil plant system was lower for high-N available treatments i.e. *Lp* N++, *Lp* + *Tr* and *Tr* and lowest for legume monoculture (Figure 5.5).

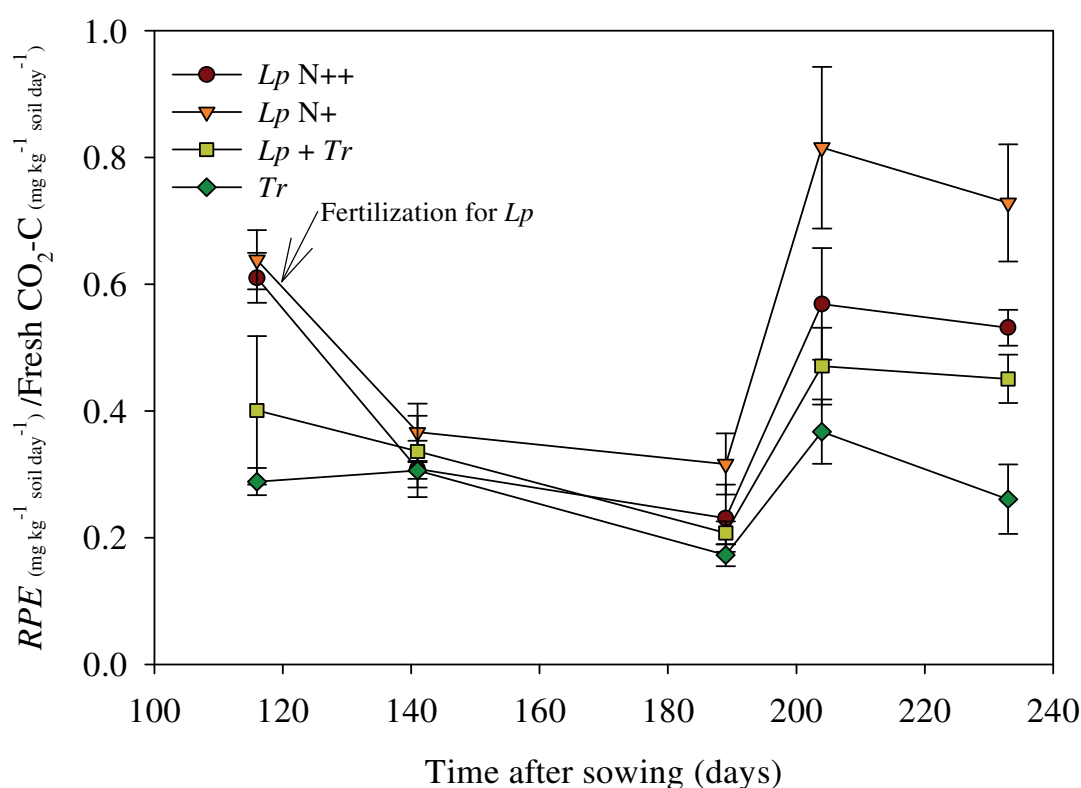

Figure 5.5. Rhizosphere priming effect induced by planted treatments expressed per unit of fresh CO₂-C respired from soil-plant system.

Our results showed that the higher N availability reduces SOM mineralization under *Lolium perenne* albeit for a short period (Figure 5.4) supporting the idea of Fontaine et al. (2004). However, in the long term *Lolium perenne* growing on high fertility soil induced higher SOM mineralization. Moreover, the legume involved treatments, wherein N availability is assumed to be higher than the demand of plants, the SOM mineralization is

higher. This is in apparent contradiction to our hypothesis. However, the lower RPE values when normalized with fresh C in high-N available treatments i.e. *Lp N++*, *Lp + Tr* and *Tr*, suggest that the higher availability of N stimulated the plant biomass, photosynthetic rates and N uptake from the soil. Higher N uptake could have caused N limitation in soil thus favouring SOM decomposers who are better adapted to assimilate fresh C under N limited conditions by mineralizing SOM and acquiring nitrogen and other nutrients from it. This result also indicates the possibility of net storage of C under high N availability. The analysis of supplementary data on soil organic C stocks will allow determining if the lower RPE in high N treatments leads to net storage of SOM.

***PART 3: DECOUPLING THE EFFECT OF ROOT EXUDATES,
MYCORRHIZAE AND ROOTS ON SOIL C PROCESSES IN
THREE TEMPERATE GRASSLAND SPECIES***

The mineralization of soil organic matter (SOM) is accelerated in the presence of living roots (Cheng et al., 2003; Dijkstra et al., 2007). However, the mechanisms developed by the plant in order to stimulate the mineralization of SOM remain poorly understood. Whether the fresh C supply to rhizosphere microbes only in form of root litter can stimulate them to increase the SOM mineralization? Do the root exudates stimulate enough to soil microbes to increase the mineralization of SOM. The results from lab incubations where soils have been amended with simple organic components of root exudates, like sugars and amino acids, are contradictory (Hamer and Marschner 2005). Moreover, the role of mycorrhizae in SOC mineralization is not clear as well though they have been shown to mineralize plant litter (Hodge et al., 2001).

In order to decouple the effects of root exudates, mycorrhizae and roots on SOM, a novel experiment was put into place. Soil, sampled from temperate grassland, was put into PVC cylinders whose cross sections were closed with 0.45 μm , 30 μm or 1000 μm mesh. Four cylinders of a particular mesh (about 60 g dry soil) were placed in inert sand in a pot. Three grassland plants i.e. *Lolium perenne*, *Poa trivialis* and *Trifolium repens* were grown on these pots and continuously labelled with ^{13}C depleted air in a mesocosm. Bare sand pots with soil cylinders (1000 μm) placed in them were used as controls. The 0.45 μm mesh was permeable only to root exudates thus corresponding to the effect of root exudates on SOM (RE treatment), 30 μm mesh was permeable to root exudates and mycorrhizae representing the effect of root exudates and mycorrhizae (RE+Myc treatment) and 1000 μm mesh being permeable to root exudates, mycorrhizae and roots represented the combined effect of all of them (whole-root treatment). The respiration from plant-soil system was measured

periodically as described earlier (Chapter 1). Thanks to ^{13}C labelling, soil-derived $\text{CO}_2\text{-C}$ was separated from plant-derived $\text{CO}_2\text{-C}$.

The presence of all grassland species significantly accelerated the mineralization of SOM ($P < 0.05$) (Figure 5.6). In *Lolium perenne*, the SOM mineralization induced by RE (0.45 μm mesh), RE+Myc (30 μm mesh) and whole-root (1000 μm mesh) was similar for first two measures. However, whole-root induced higher amount of SOM mineralization than that induced by RE or RE+Myc treatments for the third as well as final measures ($P < 0.05$). In *Poa trivialis*, the SOM mineralization by RE and RE+Myc was similar to that induced by whole-root for all the measures except the second and fourth ones where whole-root induced significantly higher SOC mineralization ($P < 0.05$). In *Trifolium repens*, the SOM mineralization induced by RE, RE+Myc and whole-root was similar except for the last measure where the whole-root treatment induced significantly higher SOM mineralization ($P < 0.05$).

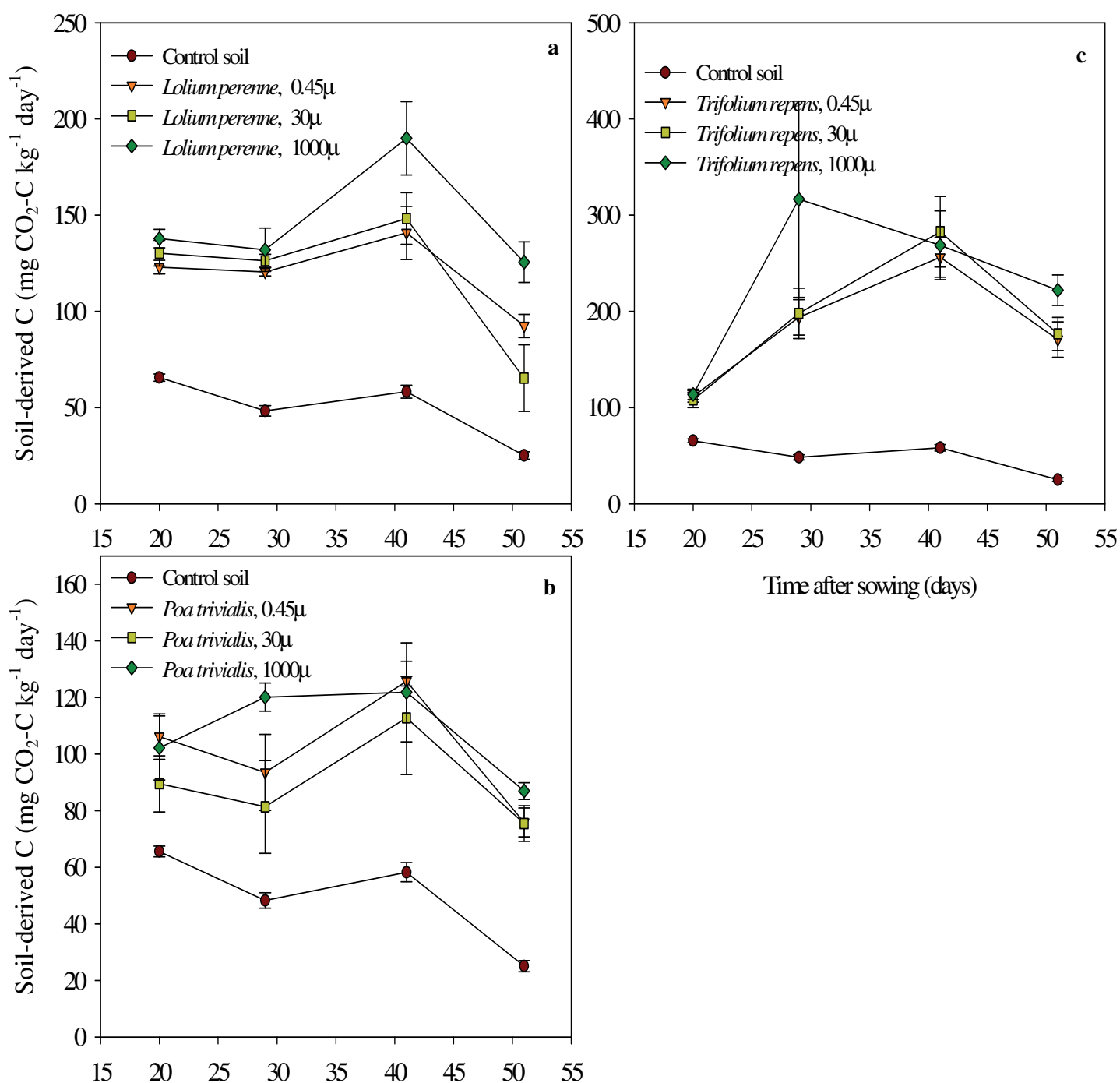

Figure 5.6. Soil derived C ($\text{mg CO}_2\text{-C kg}^{-1} \text{ soil day}^{-1}$) from control and *Lolium perenne* (a) *Poa trivialis* (b) and *Trifolium repens* (c) planted soils. 0.45 μ , 30 μ and 1000 μ represent the soil compartments where only root exudates, root exudates and mycorrhizae and root exudates, mycorrhizae and roots have excess respectively.

The results show that the stimulation of SOM induced by plants in the device using the larger pore size mesh (1000 μm) was of the same order as that observed in the plant-soil

systems without mesh (Chapter 1-3), i.e., a two to three fold increase in SOM mineralization. This indicates that our device did not disturb plant-soil interactions and hence was adapted to quantify the role of rhizosphere processes on SOM mineralization. Moreover, it clearly shows in three grassland species that root exudates induce the important acceleration (on the average twice than that in control soils) in SOM mineralization i.e. RPE was induced after of the supply of root exudates. The additive effect of mycorrhizae on RPE was inexistent throughout the experiment across three plant species suggesting that the mycorrhizae are not involved in SOM mineralization. The additional effect of roots (1000 μ m mesh) on SOM mineralization was absent initially but present towards the end of the experiment in all the species tested in the experiment. The absence of root effect initially may have been due to the fact that the roots were very young (30 days) and the root mortality did not commence hence the only fresh C supply from roots was in the form of root exudates. However, in the later stages fine roots mortality may have started supplying additional fresh C to the SOM decomposers. Therefore, our findings indicate that root exudation and deposition of root litters are the two principal ways by which plant stimulate SOM.

REFERENCES

- Cheng, W., Johnson, D.W., Fu, S., 2003. Rhizosphere effects on decomposition: controls of plant species, phenology, and fertilization. *Soil Science Society of America Journal*. 67, 1418-1427.
- Dijkstra, F.A., Cheng, W., 2007. Interactions between soil and tree roots accelerate long-term soil carbon decomposition. *Ecology Letters* 10, 1046-1053.
- Dijkstra, F.A., Hobbie, S.E., Reich, P.B., 2006. Soil Processes affected by sixteen grassland species grown under different environmental conditions. *Soil Science Society of America Journal*. 70, 770-777.
- Eviner, V.T., 2004. Plant traits that influence ecosystem processes vary independently among species. *Ecology* 85, 2215-2229.
- Fontaine, S., Bardoux, G., Abbadie, L., Mariotti, A., 2004. Carbon input to soil may decrease soil carbon content. *Ecology Letters* 7, 314-320.
- Fu, S., Cheng, W., Susfalk, R., 2002. Rhizosphere respiration varies with plant species and phenology: A greenhouse pot experiment. *Plant and Soil* 239, 133-140.
- Gruber, N., Galloway, J.N., 2008. An earth-system perspective of the global nitrogen cycle. *Nature* 451, 293-296.
- Hamer, U., Marschner, B., 2005. Priming effects in different soil types induced by fructose, alanine, oxalic acid and catechol additions. *Soil Biology and Biochemistry* 37, 445-454.
- Hodge, A., Campbell, C.D., Fitter, A.H., 2001. An arbuscular mycorrhizal fungus accelerates decomposition and acquires nitrogen directly from organic material. *Nature* 413, 297-299.

- Loiseau, P., Soussana, J.F., 1999. Elevated [CO₂], temperature increase and N supply effects on the turnover of below-ground carbon in a temperate grassland ecosystem. *Plant and Soil* 210, 233-247.
- Personeni, E., Loiseau, P., 2005. Species strategy and N fluxes in grassland soil: A question of root litter quality or rhizosphere activity? *European Journal of Agronomy* 22, 217-229.
- Wedin, D.A., Tilman, D., 1990. Species effects on nitrogen cycling: a test with perennial grasses. *Oecologia* 84, 433-441.

CHAPTER 6

General Discussion and Perspectives

ROLE OF PLANT RHIZOSPHERE ACROSS MULTIPLE SPECIES, GRASSLAND MANAGEMENT AND TEMPERATURE ON MICROBIAL COMMUNITIES AND LONG-TERM SOIL ORGANIC MATTER DYNAMICS

I. General discussion

This research work allowed bringing into light the importance of rhizospheric processes in soil C cycle through measurement of rhizosphere priming effect across multiple temperate-grassland species in an experimental system reconstituting conditions close to those encountered in ecosystems (natural light and temperature, undisturbed deep soil). Generally, the amount of soil organic matter mineralized and released as soil-derived CO₂-C from planted soils remained twice or more than twice as compared to that released from bare soils. In case of *Trifolium repens*, it reached four times than that in bare soils (Chapter 5, part 1). Moreover, the persistence of RPE for 511 days (Chapter 2) shows that this is a continuously occurring long term soil process under living plants. The amounts as well as the duration of RPE revealed by our work emphasize the significance of studying the dynamics of soil C cycle by taking into account the interaction between the supply of fresh C to soil microbes and the mineralization of recalcitrant SOM. Moreover, our work revealed the effect of various biotic (plant and microbial species) and abiotic factors (plant clipping, temperature, seasonal plant photosynthesis) on RPE intensity and hence SOM dynamics in grasslands.

The direct measurement of RPE revealed that the **plant clipping slows down the mineralization of SOM (Chapter 2)**. The detailed study was carried out on *Lolium perenne* nevertheless the results from another experiment (Chapter 5, part 1) allowed generalizing the

finding across seven grassland species. Earlier, it has been suggested that the plant defoliation may increase the mineralization of SOM owing to increased exudation thereby liberating nutrients held up in it and hence serving for plants' re-growth (Hamilton and Frank 2001; Bardgett and Wardle 2003). This would mean the C loss for soil on two fronts: decreased plant C input due to reduced aboveground biomass after defoliation and increased mineralization of existing SOM. However, our findings suggest that the plant clipping induces cascade of effects leading to decreased SOM mineralization. Clipping reduced leaf area which in turn curtails total plant photosynthesis, transpiration and uptake of mineral nitrogen (Macduff 1992). The reduced N uptake by plant led to an increase in mineral N availability for soil microorganisms, especially for soil bacteria which are typically limited by nitrogen. Given bacteria and fungi are in competition for plant C acquisition, the nitrogen-induced stimulation of bacteria suppresses fungal populations and thereby *RPE*.

As explained in Chapter 2, this strong link between above ground biomass, plant N uptake and SOM mineralization may explain the remarkable synchronization between the plant photosynthesis and the availability of mineral N in grassland soils. When plant is carrying out high amounts photosynthesis in the presence of favorable light intensity (e.g. summer season in temperate grasslands), its N uptake exceeds than the soil offer in terms of mineral N resulting in decreased availability of soil mineral N and increased fungi : bacteria ratio. These changes accelerate SOM mineralization which liberates N held up in the recalcitrant SOM stocks. On the other hand, when total photosynthesis by plant is reduced due to clipping or low light intensity, its N uptake is less than the soil offer in terms of N. The accumulation of mineral N in soil decreases SOM mineralization leading to sequestration of mineral N in SOM stocks. If this excess of nutrients is not sequestered, they would be leached or denitrified. Therefore, our study supports the idea that soil ecosystem works as a bank of

nutrients for the plant maximizing plant productivity, nutrient retention and C sequestration in the long term.

The dual labelling (^{13}C and ^{14}C) of plants developed in this thesis allowed to demonstrate that plants with deep roots are able to reactivate **the mineralization of as old recalcitrant soil C as 15,000 years by supplying soil microbes present in deep soil layers with fresh C** (Chapter 3). Therefore, our results confirm, in soil-plant systems near to field conditions, the hypothesis of Fontaine et al., (2007) that the stability of deep soil C is due to the energy limitation of microbes. Briefly, in the absence of fresh C the microbes can not mineralize humified recalcitrant SOM for long term because the energetic expense to synthesize the extra cellular enzymes and maintain cellular activity is more than the return they could get from SOM mineralization. The deep soil microbes receive fresh C in lower quantities and on less regular intervals as compared to their counterparts in surface soils thereby limiting their SOM mineralizing capacity and explaining the longer mean residence times of soil organic C in deep soils than surface soils.

As discussed in the introduction of the thesis, the knowledge about which microbes are involved in SOM mineralization and RPE, is scarce. The technical difficulties in identifying the microbial groups specialized in utilizing different C sources i.e. fresh C or recalcitrant soil organic C is the reason behind this lack of information. The correlative approach between the abundance of microbial groups and SOM mineralization used in our work (Chapter 3) suggests that **the saprophytic fungi (18:2ω6c) are key players in SOM mineralization. This idea is supported by results of Chapter 2 showing a simultaneous decrease in RPE and abundance of saprophytic fungi (18:2ω6c) after plant clipping.** Some studies (Bernard et al., 2007; Nottingham et al., 2009,) have suggested that other microbial groups like Gram negative bacteria can also induce a priming effect. **However, the strong correlation** between the abundance of microbial groups and SOM mineralization

found in this thesis combined to results of Fontaine et al.(2011) suggest that the contribution of fungi to the priming may be very large compared to the other groups. The dominance of soil fungi in the priming effect may be explained by their ability to grow as mycelium which confer them a unique capacity to access the energy contained in fresh C and to explore soil space, mine large reserve of SOM and reallocate (Frey et al., 2000; 2003) energy and nutrients from different parts of the soil.

The energy limitation of microbes to produce new enzymes and carrying out enzymatic process of mineralization of SOM (Fontaine et al., 2007) has never been considered in determining the effect of temperature on SOM mineralization. Moreover, the enzyme inactivation that occurs at all temperatures and is more sensible to temperature than specific enzymatic activity has been overlooked. By taking into account two key processes hitherto overlooked i.e. the energy limitation of microbes and the enzyme inactivation, **we predicted theoretically and validated by experimental results the negative relationship of temperature and SOM mineralization in steady-state systems (ecosystems)** (Chapter 4). The results also demonstrate the need of separating non steady-state-system like incubated bare soil wherein there is a continuous decrease in enzymatic pool, from a steady-state-system where the enzymatic pool is maintained by microbes which are supplied with fresh C like in soil-plant system. Indeed, the results show that soil C mineralization increases with temperature till an optimum in bare soil whereas it decreases with temperature in planted soil. Therefore, our findings allow to reconcile results from lab and field and to include them in a new theory describing the effect of temperature on recalcitrant soil C mineralization. They also suggest that the increase in mean temperature at global scale due to the global warming will not necessary induce the large losses of soil C predicted by current models (Jones et al., 2005).

The preliminary results of three experiments described in Chapter 5 are briefly discussed below:

Results from our experiments (Chapter 1 to 3) show that the presence of plant grasses strongly stimulates the mineralization of SOM, confirming the results obtained with other plants types (Cheng et al., 2003; Dijkstra et al., 2007). However, the mechanisms developed by the plant in order to stimulate the mineralization of SOM remain poorly understood. Some studies have suggested that the root exudation of energy-rich substrates like soluble sugars and amino acids could a way by which plants accelerate the microbial loop and the mineralization of soil N into plant rhizosphere (Clarholm, 1987, Bonkowski 2004), but the results are contradictory (Fontaine et al., 2003; Hamer and Marschner 2005). Other studies have suggested that vascular arbuscular mycorrhizae associated to herbaceous plants could directly participate in the decomposition of organic matter (Hodge et al., 2001). However, this result contradicts many observations suggesting that the enzymatic and degradation capability of vascular arbuscular mycorrhizae is highly limited. The root litters, on the other hand, are suggested to induce the acceleration in SOM mineralization (Personeni and Loiseau 2004). Therefore, a novel experiment based on the use of meshes with various pore sizes was designed in order to determine the contribution of root exudates, mycorrhizae and roots to SOM mineralization. First results show that the stimulation of SOM induced by plant grasses in the device using the larger pore size mesh (1000 μm) was of the same order as that observed in the plant-soil systems without mesh (Chapter 1-3), that is, a two to three fold increase in SOM mineralization. This indicates that our device did not disturb plant-soil interactions and hence was adapted to quantify the role of rhizosphere processes on SOM mineralization. The results also show that the RPE induced by plant grasses was almost exclusively the results of root exudates effect. The additive effect of mycorrhizae on RPE was inexistent throughout the experiment across the three plant species. The presence of roots in

soil compartments, which permitted the supply of root litter and the breaking soil aggregates, induced significantly higher RPE than that due to root exudates towards the end of the experiment (50 days after sowing). This effect only represents between 30 and 50% of that induced by root exudates. However, plants were relatively young during the experiment (52 days old) signifying the root mortality and the deposition of root litter were low during our experiment. Therefore, our findings indicate that root exudation and deposition of root litters are the two principal ways by which plant stimulate SOM.

It has been proposed that soil may function as a bank of nutrients for ecosystems (Fontaine et al., 2011). Fungal degradation of SOM is low when nutrient availability is high, and when plant demand is low, allowing sequestration of nutrients and carbon; in contrast, fungal degradation of SOM releases nutrients and carbon from soil organic matter when nutrient availability is low. This biological adjustment of soil mineral nutrients to plant uptake of nutrients may contribute to reducing N limitation of plants, minimizing nutrients loss through leaching and denitrification and building organic reserve of nutrients and carbon (Fontaine et al., 2011). To test this hypothesis, we set up an experiment where the availability of nutrients for soil microorganisms is manipulated directly through supply of mineral fertilizers to *Lolium perenne* monocultures (*Lp*) and indirectly by growing *Lolium perenne* in mix with a legume *Trifolium repens* (*Lp* + *Tr*) where legume would fix the atmospheric nitrogen and supply it into soil. When RPE was normalized with fresh C flux respired from soil plant system, high-N supplied *Lp*, mixed culture (*Lp* + *Tr*) and legume monoculture, showed the lower amounts of RPE than low N supplied *Lp* monoculture in the long term. This indicated the preliminary results from this experiment support the bank mechanism hypothesis i.e. higher availability of nitrogen reduces RPE and favours the storage of fresh C. The analysis of supplementary data on soil organic C stocks will allow determining if the lower RPE in high N treatments leads to net storage of SOM.

The plant species differ in terms of quantity and quality of rhizodeposition in soil. Moreover, they differ in terms of net N balance they induce in soil by taking up varying quantities of N and retaining it in their biomass for varying durations. In our work, we determined the SOM dynamics under six gramineae and one legume grassland species (Chapter 5, part 1). The preliminary results showed that when RPE was expressed per unit of fresh C respired from soil-plant system; legume induced the lowest RPE (< 1) suggesting the net storage of fresh C. Moreover, the gramineae species also varied in terms of RPE induced per unit of fresh C respired from soil-plant system thereby suggesting various roles vis-à-vis SOM dynamics. The role of different grassland species on SOM dynamics will be better understood after complete analysis of net soil C balance and N assimilation by plants in relation to growth strategies of plant communities e.g. conservative and high statured versus exploitative and small statured plants

II. Perspectives

A number of perspectives emerge from this work. The most important are presented below:

Our work show that the saprophytic fungi represented by the PLFA 18:2 ω 6c is linearly correlated to the priming effect induced by distinct plant species and across different soil layers. We cannot be certain that this correlation detected here and in the work of Fontaine et al. (2011), will also be observed in other soil types and ecosystems including the aquatic systems where the priming effect seems to play role in biochemical cycles as well (Guenet et al., 2010). We therefore encourage research in other ecosystems to verify the generality of this correlation at global scale. However, if this correlation is confirmed, the PLFA 18:2 ω 6c could be used as an indicator of the intensity of priming effect in soils. This biomarker will also be indicative of the quality of soils since the priming effect has a key role in the “bank functioning” of soils which naturally synchronizes the availability of mineral nutrients in soils to plant uptake of nutrients. As explained in the discussion section of the

thesis, this synchronization bring many agricultural and ecological services like minimizing nutrients loss through leaching and denitrification, maximizing primary production and building organic reserve of nutrients and carbon. Finally, the identification of microorganisms involved in the priming effect at the species level can lead to the commercial cultures of RPE-inducing microbes. These cultures can then be used for de-polluting the soils polluted by hydrocarbons given the chemical composition of soil organic matter and hydrocarbons show similarities. Moreover the microbes playing the key role in priming effect in aquatic systems can be investigated with specifically targeting this fungal group.

The persistence of strong RPE during the 511 days of experiment releasing millennia old C from deep soil horizons (Chapter 3) suggests that the pool of soil C under the control of the priming effect is very large. The future models predicting the mean residence times and turnover rates of soil organic matter in response to global change and managements should absolutely take this important soil process into account otherwise their predictions can be misleading. Our results also indicate that the ‘inert’ pool of soil organic C is not so ‘inert’ and its mineralization can be reactivated. For example, changes in land use and agricultural practices (for example, deep ploughing versus conservation tillage, use of drought resistant crops with deep root systems) that increase the distribution of fresh C at depth could stimulate loss of this ancient buried carbon. Similarly, it has been proposed that organic matter can be incorporated into deeper soil horizons by growing plants with deeper root systems and by manipulating faunal activities to transport surface organic matter to deeper horizons (Lorenz and Lal 2005). The hypothesis behind this proposal is that the organic matter deposited in deep soils is stabilized and do not interact with the pre-existent SOM, which is not supported by our results. Therefore, future proposal using deep root plants to inject organic C in deep soil layers should consider the interactions between the incorporated organic C and the pre-existent SOM and build long-term soil C balance. From an ecological perspective, it would be

interesting to test whether certain plant species have developed a strategy to reactivate deep ancient nutrients cycles in order to escape from the strong competition for nutrient acquisition in surface soil (Tilman, 1982).

It has been suggested that the increased SOM mineralization under living plants could increase the release of N from SOM (Dijkstra et al., 2008). Our experiment using *Festuca arundinaceae* to reactivate SOM mineralization in subsoil (Chapter 3) was not able to quantify the concomitant extra release of N from SOM mineralization along with RPE due to methodological problems. However, we are hopeful that we would be able to determine the consequence of the RPE on gross N mineralization in the experiment on multiple species (Chapter 5, part 1). Moreover, we encourage future research to quantify the extra release of mineral N from SOM as a result of RPE across ecosystems and soil types. If the evidence of enhanced mineral N availability due to RPE is found, the science would be one step closer to developing high performing agricultural systems which will be used to exploit the bank mechanism of soils.

Finally, the negative relationship between temperature and recalcitrant soil C mineralization identified in Chapter 4 should be confirmed in future studies by directly manipulating the temperature. This approach will facilitate the decoupling of the effect of photosynthesis and temperature since these two key controls of the priming effect co-vary in ecosystems as shown in our study. Moreover, the decrease in mineralization induced by temperature should be studied in long term to see if the decrease is maintained. Moreover, the long term effect of temperature should also be determined in long-term soil C balance that will take into account the effect of temperature on decomposition and formation (humification) of SOM. Our model could be validated under controlled conditions in an enzymatic assay with the objective to directly determine if the enzyme pool and velocity of enzyme reaction at equilibrium decreases with temperature. The lab experiment can also be used to determine the enzymatic

parameters of our model i ;e. energy of activation (EA) of specific enzyme activity and enzyme inactivation, a prerequisite to its inclusion in models of SOM dynamics.

III. References:

- Bardgett, R.D., Wardle, D.A., 2003. Herbivore-mediated linkages between aboveground and belowground communities. *Ecology* 84, 2258-2268.
- Bernard, L., Mougel, C., Maron, P.-A., Nowak, V., Lévêque, J., Henault, C., Haichar, F.e.Z., Berge, O., Marol, C., Balesdent, J., Gibiat, F., Lemanceau, P., Ranjard, L., 2007. Dynamics and identification of soil microbial populations actively assimilating carbon from ¹³C-labelled wheat residue as estimated by DNA- and RNA-SIP techniques. *Environmental Microbiology* 9, 752-764.
- Bonkowski, M., 2004. Protozoa and plant growth: the microbial loop in soil revisited. *New Phytologist* 162, 617-631.
- Cheng, W., Johnson, D.W., Fu, S., 2003. Rhizosphere effects on decomposition: controls of plant species, phenology, and fertilization. *Soil Sci. Soc. Am. J.* 67, 1418-1427.
- Clarholm, M., 1985. Interactions of bacteria, protozoa and plants leading to mineralization of soil nitrogen. *Soil Biology and Biochemistry* 17, 181-187.
- Dijkstra, F.A., Cheng, W., 2007. Interactions between soil and tree roots accelerate long-term soil carbon decomposition. *Ecology Letters* 10, 1046-1053.
- Dijkstra, F.A., Pendall, E., Mosier, A.R., King, J.Y., Milchunas, D.G., Morgan, J.A., 2008. Long-term enhancement of N availability and plant growth under elevated CO₂ in a semi-arid grassland. *Functional Ecology* 22, 975-982.
- Fontaine, S., Barot, S., Barre, P., Bdioui, N., Mary, B., Rumpel, C., 2007. Stability of organic carbon in deep soil layers controlled by fresh carbon supply. *Nature* 450, 277-280.
- Fontaine, S., Henault, C., Aamor, A., Bdioui, N., Bloor, J.M.G., Maire, V., Mary, B., Revaillet, S., Maron, P.A., 2011. Fungi mediate long term sequestration of carbon and nitrogen in soil through their priming effect. *Soil Biology and Biochemistry* 43, 86-96.

- Fontaine, S., Mariotti, A., Abbadie, L., 2003. The priming effect of organic matter: a question of microbial competition? *Soil Biology and Biochemistry* 35, 837-843.
- Frey, S.D., Elliott, E.T., Paustian, K., Peterson, G.A., 2000. Fungal translocation as a mechanism for soil nitrogen inputs to surface residue decomposition in a no-tillage agroecosystem. *Soil Biology and Biochemistry* 32, 689-698.
- Frey, S.D., Six, J., Elliott, E.T., 2003. Reciprocal transfer of carbon and nitrogen by decomposer fungi at the soil-litter interface. *Soil Biology and Biochemistry* 35, 1001-1004.
- Guenet, B., Danger, M., Abbadie, L., Lacroix, G., 2010. Priming effect: bridging the gap between terrestrial and aquatic ecology. *Ecology* 91, 2850-2861.
- Hamer, U., Marschner, B., 2005. Priming effects in different soil types induced by fructose, alanine, oxalic acid and catechol additions. *Soil Biology and Biochemistry* 37, 445-454.
- Hamilton, E.W., Frank, D.A., 2001. Can plants stimulate soil microbes and their own nutrient supply? Evidence from a grazing tolerant grass. *Ecology* 82, 2397-2402.
- Hodge, A., Campbell, C.D., Fitter, A.H., 2001. An arbuscular mycorrhizal fungus accelerates decomposition and acquires nitrogen directly from organic material. *Nature* 413, 297-299.
- Jones, C., McConnell, C., Coleman, K., Cox, P., Falloon, P., Jenkinson, D., Powlson, D., 2005. Global climate change and soil carbon stocks; predictions from two contrasting models for the turnover of organic carbon in soil. *Global Change Biology* 11, 154-166.
- Lorenz, K., Lal, R., Donald, L.S., 2005. The Depth distribution of soil organic carbon in relation to land use and management and the potential of carbon sequestration in subsoil horizons, *Advances in Agronomy*. Academic Press, pp. 35-66.

- Macduff, J.H., Jackson, S.B., 1992. Influx and efflux of nitrate and ammonium in Italian ryegrass and white Clover Roots- comparisons between effects of darkness and defoliation. *Journal of Experimental Botany* 43, 525-535.
- Nottingham, A.T., Griffiths, H., Chamberlain, P.M., Stott, A.W., Tanner, E.V.J., 2009. Soil priming by sugar and leaf-litter substrates: A link to microbial groups. *Applied Soil Ecology* 42, 183-190.
- Personeni, E., Loiseau, P., 2004. How does the nature of living and dead roots affect the residence time of carbon in the root litter continuum? *Plant and Soil* 267, 129-141.
- Tilman, D. (1982) *Resource competition and community structure* (Princeton Univ. Press, Princeton).

APPENDIX OF THE THESIS

Acellular respiration: reconstitution of an oxidative metabolism by enzymes released from dead cells

Annex of the Thesis

***ACELLULAR RESPIRATION: RECONSTITUTION OF AN
OXIDATIVE METABOLISM BY ENZYMES RELEASED FROM
DEAD CELLS***

Vincent Maire¹, Gaël Alvarez^{1,2}, Jonathan Colombet³, Aurélie Comby¹, Romain Despinasse⁴, Eric Dubreucq⁵, Muriel Joly¹, Anne-Catherine Lehours³, Véronique Perrier⁵, Tanvir Shahzad¹ and Sébastien Fontaine¹

1. INRA, UR 874 UREP, 63100 Clermont-Ferrand, France

2. Clermont Université, VetAgro Sup, 63000, Clermont-Ferrand, France

3. University of Clermont Ferrand, UMR 6023 LMGE, 63177 Aubière, France

4. INRA, UMR 1095 UBP, 63100 Clermont-Ferrand, France

5. Montpellier SupAgro, UMR 1208 IATE, 34060 Montpellier, France

*Authors for correspondence (phone +33 473 62 48 72; fax +33 473 62 44 57; e-mail, fontaine@clermont.inra.fr)

Email: vmair24@gmail.com; Eric.Dubreucq@supagro.inra.fr; A-Catherine.Lehours@univ-bpclermont.fr; gael.alvarez@vetagro-sup.fr; tshahzad@clermont.inra.fr; despinasseromain@gmail.com; majorelie@hotmail.fr; muriel.mourguy@gmail.com; perrier@supagro.inra.fr; jocolomb@univ-bpclermont.fr

Abstract 124 words; Total word count: 4148

Figure: 4; Supplementary online material: 9

Key Words: cellular respiration; enzyme activity; soil enzyme stability; oxidative metabolism; fermentative metabolism; life origin; soil memory, biotechnology.

Almost all the life is fuelled by energy released from cellular respiration, also known as oxidative metabolism. This metabolism implies a high number of biochemical reactions requiring many enzymes, co-factors and strict physico-chemical conditions. Given this complexity, it is believed that only a living cell is able to organize the cascade of reactions leading to respiration. Here we show that enzymes released from dead cells reconstitute an oxidative metabolism in water and soil without cellular organization. This acellular respiration can contribute to 16-48% of soil respiration. These results indicate that, when all relevant organic molecules are present, complex biochemical reactions underpinning bioenergetics of life can occur spontaneously without living structure. The first ancestral oxidative metabolism may have occurred in soil before the first cells.

The cellular respiration involves the coupled oxidation of one organic molecule (*e.g.* glucose) with the reduction of another (*e.g.* O₂), which generally leads to the release of CO₂. Outside the cell catalytic environment, the organic molecules are generally highly stable. For instance, the oxidation of one molecule of glucose through the combustion process requires a temperature greater than 500°C. Consequently, the oxidation of organic molecules by heterotrophic organisms involves a range of intracellular enzymes that decrease the activation energy of this reaction. It is commonly accepted that these enzymes cannot function outside the cell because they depend on various co-factors (*e.g.* NAD⁺), on being located adjacent to other enzymes for exchanges of substrates and products, and on some physiological properties of the cell (*e.g.* redox potential) (1-3). However, some studies have shown persistence of CO₂ production in soils where microbial life had been removed or at least strongly reduced, by exposition to toxics (ClCH₃, orange acridine) or irradiation (4-7). It is well known that many enzymes secreted by microorganisms and released from dead cells are present in soil (3), but it is generally considered that respiration is associated with living cells only. The origin of this CO₂ production in the absence of living microorganisms remains largely unknown and challenges our basic knowledge of biology.

Origin of CO₂ production in soil deprived of life. We investigated this origin in five top soils (0-20 cm) sampled in 2010 in different regions of the world. The soils of Bugac (Hungary), Laqueuille (France), Ponta Grossa (Brasil), Soro (Denmark) and Theix (France) presented textures from sandy-silted to silty-clay soils, pH from 4.3 to 8.6 and two different vegetation covers (grassland and forest) (8, SI1). The soil of Theix, which is a cambisol, was used for all investigations whereas the other soils were only used to generalize the key findings of this study. Soils were exposed to γ -irradiation (45kGy) to kill soil organisms.

Typically, γ -irradiation at 20 kGy eliminates cultivable bacteria, actinomycetes and fungi (9). The γ -irradiated soil was then incubated under sterile conditions at 30°C to quantify the production of CO₂. Non-irradiated living soil was also incubated as a control. The effect of γ -irradiation on soil microorganisms and the sterility of microcosms were investigated using four complementary methods applied to incubated soils: i) quantifying the changes in microbial biomass (10); ii) enumerating morphological intact cells by transmission electron microscopy (11, SI2); iii) searching for the presence of γ -resistant cultivable microorganisms (e.g. *Deinococcus radiodurans* (12-13)); and iv) counting functional RNA-producing microorganisms in soils by using fluorescence *in-situ* hybridization (TSA FISH (14)). Finally, in order to check that our methods were able to detect the presence of functional living microorganisms in low density, we determined the sensibility of TSA-FISH method (SI2) and experimentally simulated a contamination of irradiated soil microcosms by inoculating them with soil inoculum. The microbial biomass brought by this inoculation represented 1/1900 of the microbial biomass present in the non-irradiated soil.

In spite of their exposure to γ -irradiation, the five tested soils still released large quantities of CO₂, corresponding to 20-100% of the CO₂ released by the non-irradiated soils after two days of incubation (Fig. 1A). This proportion decreased during the first part of the incubation (0-6 days) and stabilized at 20-60% depending significantly on soil type at the end of incubation (21 days). The incubation duration for the Theix soil was extended to test whether CO₂ production endured in the long term. Significant CO₂ production was measured during 332 days and 50% of the initial production rate was only reached after 165 days (Fig. 1B). Although the release of CO₂ from soil inorganic carbon reserve (e.g. CaCO₃) may have partly contributed to the production of CO₂ in the alkaline soil of Bugac (15), this chemical process cannot explain the release of CO₂ in the other soils. We therefore tested the hypothesis that this production of CO₂ resulted from an oxidative metabolism by incubating the irradiated soil of Theix with ¹³C-labeled glucose. Figure 1C shows that added glucose was oxidized in ¹³CO₂, while figure 1D shows that the accumulation of CO₂ mirrored the consumption of O₂ leading to a respiratory quotient (CO₂/O₂) of 0.96, which is typical of the respiratory activity of cells.

What was the effect of γ -irradiation on soil microorganisms? Irradiation strongly reduced the microbial biomass measured in the soil of Theix, from 1000 in the non-irradiated soil to 200 mgC kg⁻¹ in the irradiated soil at the beginning of incubation (Fig. 2A). Moreover, transmission electron microscopy showed that irradiation caused many damages to cells such as membrane disruption and loss of cell turgescence (Fig. 2E). After irradiation of Theix soil,

number of morphological intact cells was divided by 16 (Fig 2D) whereas the respiration rate was only divided by 1.25 after two days of incubation (Fig 1A). Our results also showed that the remaining cells were not viable or functional. Indeed, microbial biomass continuously decreased during the incubation reaching undetectable value at day 13 (Fig. 2A), indicating that this microbial biomass was not viable and lysed. Furthermore, no culture from any soil revealed the presence of viable and cultivable microbes (SI1). Finally, functional RNA-producing cells were not detected in the irradiated soil of Theix irrespective of sampling date (Fig. 2B). This showed that the cells remaining after irradiation did not provide RNA and thereby respiratory enzymes anymore. Of course, we cannot exclude the possibility that some functional RNA-producing cells remained in irradiated soil and were undetected by our method. However, based on the specific respiratory activity of soil microorganisms calculated in the living soil (respiration per unit cell, Fig 1E and 2B incubation period 0-2 days), we calculated that respiration in the irradiated soil corresponded at least to an activity of 4.10^9 cells g^{-1} soil. Given that the TSA-FISH method was able detecting the presence of 10^5 cells g^{-1} soil (SI2), we quantified that the potential contribution of undetectable cells to the respiration observed in irradiated soil cannot exceed 1/10,000. Consistently, the simulated contamination of irradiated soil was immediately detected by the TSA-FISH method (Fig. 2B). This contamination was followed by a flush of respiration and growth of microorganisms using the soluble C released by the killed biomass (Fig. 1E; 2A-C). Collectively, these results strongly suggest that respiration fluxes recorded after irradiation cannot be attributed to cellular activities.

Respiration as an acellular metabolism. Given that an oxidative metabolism could be maintained in environment deprived of life, we propose the idea that respiration can be an acellular process. We suggest that even in the absence of living cells, an oxidative metabolism can be carried out by enzymes released from dead cells. At the end of the respiratory chain, the transfer of electrons to O_2 could be supported by microbial membrane debris and soil particles due to their electric charge (16) allowing a regeneration of co-factors (e.g. NAD^+). To test the hypothesis of an acellular respiration (AR), a fresh cell-free extract of yeast (*Pichia pastoris*) containing enzymes of glycolysis and Krebs cycle was produced (SI3). Immediately after production (17), the yeast cell-free extract was incubated with ^{13}C labeled glucose in water and in irradiated soil of Theix (W+G+YE and S+G+YE treatments). Water with glucose, irradiated soil with and without glucose were also incubated as controls (W+G, S and S+G treatments, respectively). The ability of enzymes present in the yeast extract to carry out an acellular respiration was tested by quantifying fluxes of CO_2 , $^{13}CO_2$ and O_2 in

water and soil microcosms. Second glucose supply was applied after 20 days of incubation in order to determine the long term respiratory capabilities of enzymes. Sterility of microcosms was verified after 0, 2 and 53 days of incubation through direct microscopic observations (water microcosms) and TSA-FISH method.

Microscopic observations and TSA-FISH measurements indicated that there was no microbial contamination throughout the experiment. The production of CO₂ was null in water with glucose (W+G, data not shown) and low in the two control soils (S and S+G, Fig 3A-B). The supply of glucose had no effect on soil respiration (S *versus* S+G) indicating that C-substrate availability was not a limiting factor for respiration in irradiated soil. In contrast, the supply of yeast extract to water and soil microcosms (W+G+YE and S+G+YE, respectively) triggered enormous respiration fluxes. Respiration from W+G+YE and S+G+YE respectively represented 725 and 72 times the flux observed in control soils (Day 0.75, Fig. 3A-B). This over-respiration was maintained in water and soil microcosms over the 53 days of incubation though significantly decreased in intensity with time (Fig. 3A-B). The respired C originated from added labeled glucose and unlabelled substrates present in yeast extract and soil (SI4). Thus, an equivalent of glycolysis and Krebs cycle was reconstituted by enzymes of yeast extract. These results confirm the idea that respiration can be acellular. Interestingly, the production of CO₂ systematically mirrored the consumption of O₂ in any treatments and dates, unless in the W+G+YE treatment at day 0.75 (respiratory quotient = 2, Fig. 3A). In this case, the availability of O₂ was reduced, metabolic activity was intense and the pressure into microcosms rose to 1.25 atm, which indicated the presence of fermentative metabolism (Fig. 3A-B). These results suggest that without any cellular regulation, enzymes were able to switch between oxidative and fermentative metabolisms in function to the redox condition of microcosms. At short term, acellular respiration was significantly higher in water than soil microcosms, which can be explained by various toxic and inhibiting molecules present in soil and some interactions with soil minerals that can affect enzyme activity (3). After 20 days of incubation, acellular respiration in W+G+YE treatment was very low representing 17% of control soil respiration while it was stabilized in S+G+YE treatment at a rate representing 247% of control soil respiration. The lower respiration in water than in soil microcosms after 20 days was due to an inactivation of enzymes and not to an exhaustion of C-substrate since the second glucose supply had no effect on respiration rate (SI5). These results suggest that part of added enzymes was protected from inactivation in soil allowing persistence of acellular respiration over long term.

Soil stabilization of oxidative metabolism enzymes. It is well known that soil particles (soil minerals and humus) can stabilize extracellular enzymes secreted by soil microorganisms (3, 18). However, this soil stabilization has not yet been proved for enzymes that are commonly found into living cells. In order to test the ability of soil particles to stabilize enzymes involved in respiration, three specific enzymes involved in glycolysis (GHK: glucose hexokinase, G6PI: glucose-6-phosphate isomerase) and the Krebs cycle (MDH: malate dehydrogenase) were incubated in non-irradiated living soil of Theix (SI6). The activity measurement (adapted from 19) of free *vs* immobilized enzymes were realized separately during one month quantifying the protective role of soil particles. The results were generalized to the four other soils by using the G6PI enzyme as a model.

The activity of GHK, G6PI and MDH persisted in soil over several weeks of incubation (Fig. 4A-C). The analysis of their kinetics indicated the existence of fast-, intermediate- and slow-cycling pools of enzymes in the soil (Fig 4A-C, SI7). Among enzymes, 36-66% of the initial enzymatic activity was lost within minutes following enzyme addition to the soil, likely due to physico-chemical processes (3). A second pool of enzymes representing 29-58% of the initial activity was inactivated more slowly with a mean residence time (MRT) of 13-38 hours. The soil proteolytic activity probably contributed to the degradation of this pool (20). Finally, 5-14% of the initial enzymatic activity was retained in a highly stable form with MRT of 45-714 days depending upon the enzyme examined. Figures 4A-C show that this long-term persistence of enzymatic activities relied on enzymes immobilized on soil particles, as no soluble enzyme activity was detected after 20 days. This confirms the role of soil particles for the preservation of intracellular enzymes. Our investigations in the other soils gave consistent results with a fraction between 0.8-3.3% of the initial enzymatic activity that became stabilized into the soil (SI8). Overall, the key role of soil particles in the acellular respiration (AR) was supported by significant positive correlation between production of CO₂ and fine particle content (Clay+Loam; $n = 4$, $r^2 = 0.94$, $p < 0.05$) and soil exchange capacity ($n = 4$, $r^2 = 0.95$, $p < 0.05$) of irradiated soils (Bugac soil was excluded from correlations due to its alkalinity biasing soil CO₂ production (15)).

Contribution of acellular respiration to CO₂ production from living soil. Given that the respiration in the irradiated soil cannot be explained by cellular activities, we assume that CO₂ production from this soil was acellular. However, the irradiation by killing many active microbes has released a large quantity of intracellular enzymes in irradiated soil increasing artificially AR. Consequently, the respiration in irradiated and non-irradiated soils

cannot be directly compared to estimate the AR contribution in living soils. This contribution can be quantified using a simple model (SI9):

$$R_{ni} = R_l + R_d$$

$$R_i = R_l * k + R_d$$

Where R_{ni} is the release of CO₂ in the non-irradiated soil, R_l and R_d are the respiration attributed to living microbes and the acellular oxidative metabolism (AR) respectively, R_i is the release of CO₂ in irradiated soil and k is the fraction of R_l that persisted in the soil after irradiation because of the soil stabilization of enzymes released from dead cells. An additional incubation with intracellular enzyme in irradiated soils was set up to estimate parameter k for three of the five soils (SI9). We found that the contribution of AR might be very large, representing 16-48% of CO₂ released in the living soils. This unexpected contribution is likely the result of the long term accumulation in soils of slow-cycling enzymes protected by soil particles (Fig. 4A-C). Furthermore, the concentration of intracellular enzymes on soil particles could allow exchanges of co-substrates and co-factors between enzymes, which are necessary for the cascade of reactions implied in oxidative metabolism.

Acellular respiration in extreme environments. Given that soil AR is carried out by soil-protected enzymes and not by living microbes that have tight physiological constraints, we assumed that AR would show specific properties like resistance against high temperature, pressure and toxics. To test this hypothesis, we exposed irradiated soil of *Theix* to high temperature (150°C), autoclaving (137°C and 2.4 10⁵Pa) and toxics (chloroform vapors). These treatments are considered to be lethal for most microorganisms and to denature enzymes (21). Although treatments significantly diminished respiration activities a substantial part of these activities was maintained (t-tests, $P < 0.05$, Fig. 1E). For example, 50, 20 and 10% of the AR was maintained after exposures to chloroform, high temperature and autoclaving, respectively. Thus, soil particles not only protect enzymes against denaturation (20, 22) but also allow the maintenance of complex metabolism such as respiration in conditions where life is generally not possible.

Conclusion and perspectives. These results indicate that a substantial part of soil respiration originates from acellular oxidative metabolisms that do not follow classical biological rules (23-24). Thus, soil respiration is driven by two oxidative metabolisms: 1) activity and diversity of living microbial populations (25); 2) activity of a stable pool of dead-originated enzymes. Further experiments are necessary to better understand the molecular

mechanisms at play and quantify the AR across soils. However, the AR is likely to be common in many soil types as consistent results were found in the five contrasted studied soils. Moreover, the reconstitution of intracellular metabolism outside the cell could occur in other environments (water, sediments) and may concern other metabolisms (methanisation, denitrification) since it only requires the presence of dead cells releasing intracellular enzymes. We therefore encourage research in other environments to quantify the relative role of acellular metabolisms at the global scale.

These results have several implications. In biology, our results support the idea that soil minerals have played a key role in the origin of life (26-27). Previous studies have shown the role of minerals in the concentration and polymerization of amino acids and nucleic acids provided during the prebiotic period (27). Our results show that, when all relevant organic molecules are present, complex biochemical reactions underpinning bioenergetics of life (respiration) can occur spontaneously in the soil. Thus, the first ancestral oxidative metabolism may have occurred in soil before the presence of the first cells. In biogeoscience, our results show that AR can be very stable over time (*e.g.* MRT of MDH >714 days) indicating that soil enzyme and respiration activities must in part originate from past microbial activities. This memory of soils suggests the existence of lag phase between the modification of microbial activities and its consequence on soil respiration. It could explain why many short-term experiments manipulating the diversity of soil microorganisms fail to demonstrate links between soil biodiversity and functions (28). From an applied perspective, the ability of soil particles to stabilize a high number of enzymes and trigger a cascade of sustainable biochemical reactions (with cofactors regeneration) may be used as template for designing non-biological systems able to reproduce complex pathways of microbial metabolism. These systems could produce valuable compounds and electricity (biobattery (29)) in the absence of microorganisms that may consume products, be pathogens and require specific environmental conditions. The high stability of soil-bound, cell-free enzymes would be another peculiar advantage of such systems.

REFERENCES

1. H. Krebs, *Philos. T. R. Soc. B.* **293**, 3 (1981).
2. P. R. Rich, *Biochem. Soc. T.* **31**, 1095 (2003).
3. R. G. Burns, *Soil Biol. Biochem.* **14**, 423 (1982).
4. G. H. Peterson, *Soil Science* **94**, 71-74 (1962).
5. A. J. Ramsay, A. D. Bawden, *Soil Biol. Biochem.* **15**, 263 (1983).
6. R. Lensi, C. Lescure, C. Steinberg, J.M. Savoie, G. Faurie, *Soil Biol. Biochem.* **23**, 367 (1991).
7. J.T. Trevors, *J. Microbiol. Meth.* **26**, 53 (1996).
8. D. Baldocchi, *Aust. J. Bot.* **56**, 1 (2008).
9. N. P. McNamara, H. I. J. Black, N. A. Beresford, N. R. Parekh, *Appl. Soil Ecol.* **24**, 117 (2003).
10. E. D. Vance, P. C. Brookes, D. S. Jenkinson, *Soil Biol. Biochem.* **19**, 703 (1987).
11. J. Colombet, *et al.*, *App. Environ. Microbiol.* **72**, 4440 (2006).
12. F. A. Rainey, *et al.*, *Appl. Environ. Microbiol.* **71**, 5225 (2005).
13. J. H. Warcup, *T. Brit. Mycol. Soc.* **34**, 376 (1950).
14. I. C. Biegala, F. Not, D. Vaultot, N. Simon, *Appl. Environ. Microbiol.* **69**, 5519 (2003).
15. I. Bertrand, O. Delfosse, B. Mary, *Soil Biol. Biochem.* **39**, 276 (2007).
16. J. T. Trevors, C. I. Mayfield, W. E. Inniss, *Microb. Ecol.* **8**, 163 (1982).
17. G. J. Vanderheiden, A. C. Fairchild, G. R. Jago, *Appl Microbiol* **19**, 875 (1970).
18. R. L. Sinsabaugh, M. J. Klug, H. P. Collins, P. E. Yeager, S. O. Petersen, *Characterising soil microbial communities*, in G. P. Robertson, D. C. Coleman, C. S. Bledsoe, P. Sollins, Eds. *Standard soil methods for long term ecological research.*(Oxford University Press, New York, 1999) pp. 318-348.
19. S. Nardi, *et al.*, *Soil Biol. Biochem.* **39**, 3138 (2007).
20. J. M. Sarkar, A. Leonowicz, J. M. Bollag, *Soil Biol. Biochem.* **21**: 223 (1989).
21. K. Kashefi, D. R. Lovley, *Science* **301**, 934 (2003).
22. P. Lähdesmäki, R. Pnspanen, *Soil Biol. Biochem.* **24**, 1173 (1992).
23. H. Koffler, G. E. Mallett, J. Adye, *P. Natl. Acad. Sci. Biol.* **43**, 464 (1957).
24. P. Lopez-Garcia, *Adv. Astrobio. Biogeop.* **2**, 221 (2007)
25. S. Fontaine, S. Barot, *Ecol. Lett.* **8**, 1075 (2005).
26. R. M. Hazen, *Am. Mineral.* **91**, 1715 (2006).
27. J. D. Bernal, *Proc. Phys. Soc.* **B62**, 597 (1949).
28. B. S. Griffiths, *et al.*, *Soil Biol. Biochem.* **33**, 1713 (2001).

29. S. Kerzenmacher, J. Ducr e, R. Zengerle, F. von Stetten, *J Power Sources* **182**, 1 (2008).

SUPPORTING ONLINE MATERIAL

Materials and Methods

SI1: Physical and chemical properties of five studied soils and counting of γ -resistant cultivable microbes.

SI2: Detailed methods for the transmission electron microscopy and the TSA-FISH.

SI3: Detailed method for the yeast extract production.

SI4: Unlabelled and labeled carbon released as CO₂ in water and soil microcosms.

SI5: Effect of the second glucose supply on microcosm respiration.

SI6: Detailed method for the measurement of enzymatic activities involved in glycolysis and the Krebs cycle in soil.

SI7: Analysis of the three cycling pools of intracellular enzymes in the soil of Theix.

SI8: Generalization of result on intracellular enzyme stabilization to the five studied soils.

SI9: Estimation of acellular respiration in living soil.

References (30-36)

FIGURE LEGEND

Figure 1: Gas flux exchanges during incubations of soil and water microcosms.

(A) Ratio between the CO₂ produced in the irradiated and the non-irradiated soil for the five studied soils incubated in aerobic conditions. Symbols are labeled as: red D2, incubation day 2; orange D6, incubation day 6; clear green D13, incubation day 13; dark green D21, incubation day 21. Letters indicate the differences at 5% *P*-level between measurements over time (lower case) and across soils (upper case) based on repeated-measures analysis of variance. (B) Exponential decrease of CO₂ production rate in the irradiated soil of Theix incubated during 48 week. The half-life ($t_{1/2}$) and mean residence (MRT) times were calculated from the exponential model $Y(t)=A_0e^{-kt}$ where $Y(t)$ is the production rate of CO₂ with time, A_0 the initial production rate and k the rate decay. (C) Isotopic composition (in ‰ delta ¹³C) of CO₂ released by the irradiated soil of Theix after addition of ¹³C labeled glucose. (D) Cumulated production of CO₂ and consumption of O₂ induced by incubation of the irradiated soil of Theix. Full and dashed lines represent the fit of linear regressions and their error intervals at 5% *P*-level, respectively. (E) Cumulated CO₂ production in response to different treatments applied to soil of Theix. Symbols are labeled as follows: brown ●, non-irradiated control soil; orange ●, irradiation; clear green ▼, irradiation + 150°C; dark green ▲, irradiation + fumigation; clear blue ■, irradiation + autoclaving; dark blue ■, irradiation + re-inoculation with a soil inoculum to simulate a contamination.

Figure 2: Tests for the presence / absence of microbes in the soil of Theix.

Dynamics of (A) microbial biomass, (B) count of TSA-FISH stained cells and (C) Soluble C in irradiated soil (black bars), living control soil (white bars), irradiated and re-inoculated soil (grey bars). Differences from zero of different variables were tested with t-test at 5% *P*-level. Abbreviation: ns, non significant. (D) Count of morphological intact cells by transmission electron microscopy in living control soil (white bars) and in irradiated soil (black bars) after 0 and 190 days of incubation. Differences between living control and irradiated soils were tested with t-tests at 5% *P*-level. Number of cells in the two irradiated soils was not significantly different from zero (t-test, 5% *P*-level). (E) Transmission electron micrographs of injured (graphs 1 to 5) and morphological intact cells (graphs 6 to 7). The arrow on graphs 4 indicates a membrane disruption. The scale black bar corresponds to 500 nm length.

Figure 3: Acellular respiration induced by cell-free yeast extract incubated in water and soil microcosms.

(A) Production of CO₂ and consumption of O₂ by soil and water microcosms from the yeast extract incubation for four periods of incubation. Symbols are labeled as follows: orange S, irradiated soil; clear green S+G, irradiated soil + labeled glucose; dark green S+G+YE, irradiated soil + labeled glucose + yeast extract; brown W+G+YE, water + labeled glucose + yeast extract. Water with labeled glucose was also incubated as control, but the production of CO₂ from this control was null and not reported into the figure. Letters indicate at each sampling date the differences at 5% *P*-level among treatments based on an ANOVA. (B) Production rate of CO₂ released by water and soil microcosms. Symbols are same to Fig. 3B.

Figure 4: Activity of oxidative metabolism enzymes in the soil of Theix.

Fate of the activity of three specific enzymes (*A_j*) involved in glycolysis and the Krebs cycle following their incorporation into the living control soil. Enzyme activity is expressed as % of the activity of enzymatic solution incorporated into the soil. The activity of enzymes, free in soil solution (full circles) and immobilized on soil particles (empty circles), are distinguished. Full, dashed and dotted lines represent the fit of double exponential models, their confidence and predictive error intervals at 5% *P*-level, respectively. (A) G6PDH: glucose-6-phosphate dehydrogenase; (B) GHK: glucose hexokinase; (C) MDH: malate dehydrogenase.

❖ **ACKNOWLEDGMENTS:** We thank D. Tourvieille M. Leguillon, D. Jolivot, F. Cambon. and the “Plant and Pathogen” team of the UMR-INRA 1095 for their technical support. We thank P. Ambus, L. da Silveira Pontes, and L. Horváth who respectively sampled the soil in Denmark, Brazil and Hungary respectively; C. Mallet for culture analysis; S. Revaillet, O. Delfosse and J.-L. Ollier for chemical and isotopic analyses; L. Genestoux, C. Chabaliier, F.-X. Sauvage, N. Duchatau for intracellular enzymatic activity analyses, G. Borrel for gas spectrometry; and V. Allard, P. Barré, S. Barot, J. Bloor & R. Pilon for their constructive comments on a previous version of the manuscript. The research leading to these results has received funding from the French Institutes INRA-INRIA (ARC-VitelBio), the French national agency ANR (DIMIMOS) and the European Community's 6th and 7th Framework Programs (FP6 and FP7) under grant agreement n° 017841 (Nitro-Europe) and n° 226701 (CARBO-Extreme). All authors have refused to apply for the research bonus scheme set up by the French government in 2010 and have consequently no competing financial interest in this work.

AUTHOR CONTRIBUTIONS: This work originated from an idea of SF; VM, ED and SF designed experiments; RD and MJ conducted soil incubations and counting of cultivable

microorganisms; RD and VM performed gas spectrometry; ACL and VM performed fluorescence in situ hybridization (TSA-FISH); VM and SF conducted the incubation experiment with intracellular enzymes; GA, VP, ED and SF conducted the incubation experiment with yeast extract; SF built the model for estimating acellular respiration in soils; VM, TS and SF wrote the manuscript; and all authors took part in the interpretation of the results.

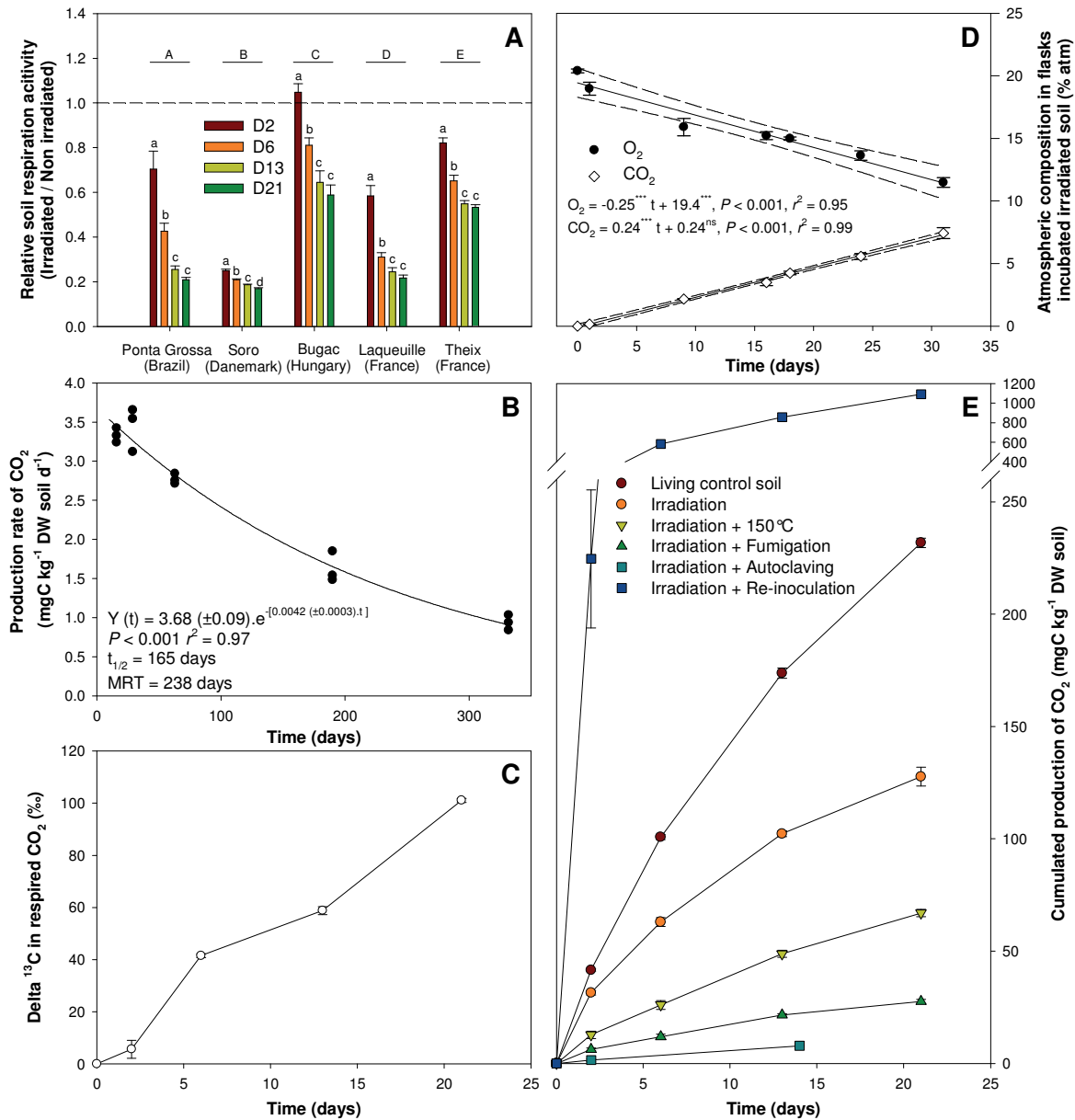

Figure 1: Gas fluxes produced during incubations of irradiated (45 kGy) and non-irradiated living soils

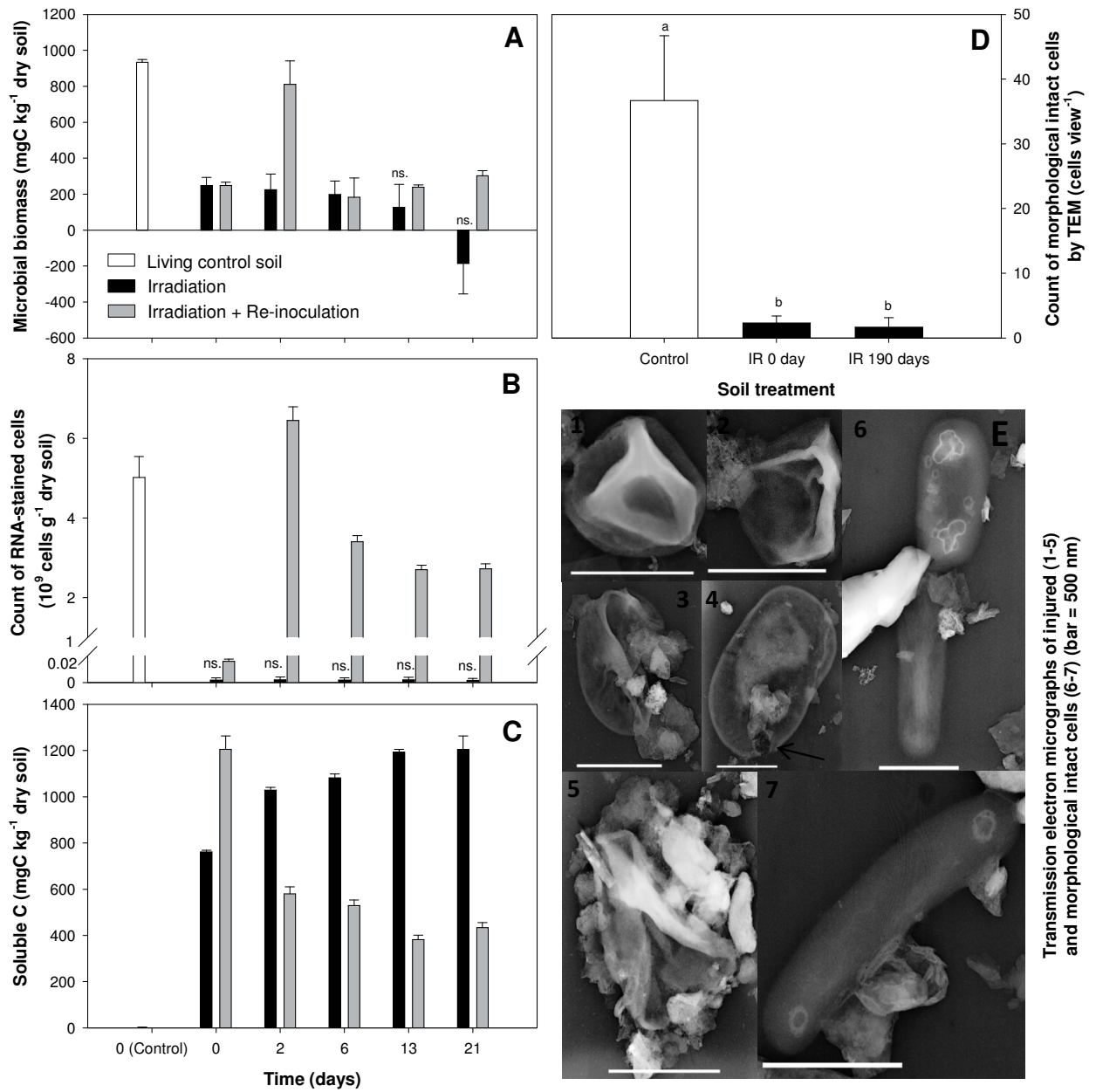

Figure 2: Test of presence / absence of microbes in the soil of Theix.

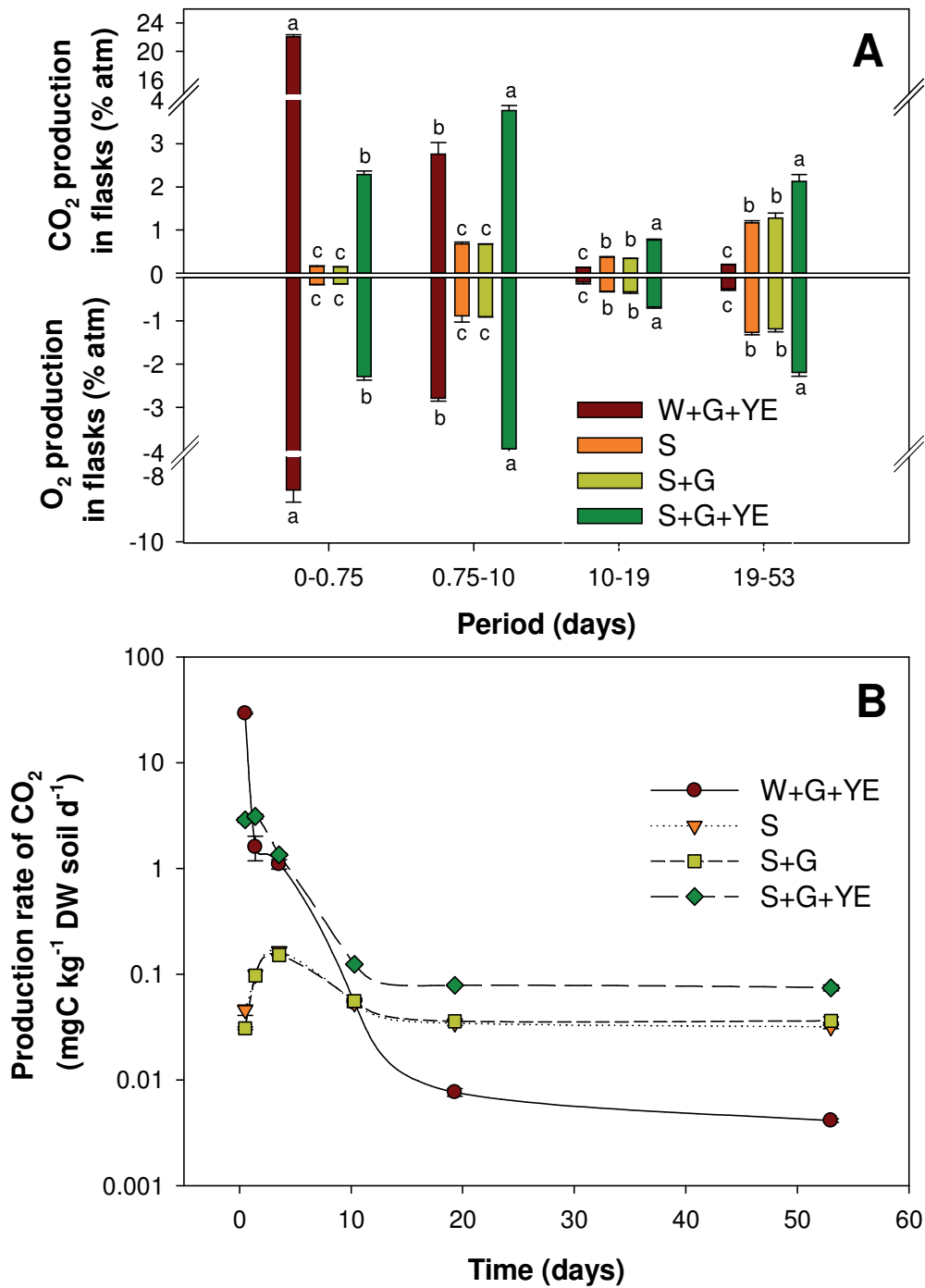

Figure 3: Acellular respiration induced by cell-free yeast extract incubated in water and soil microcosms

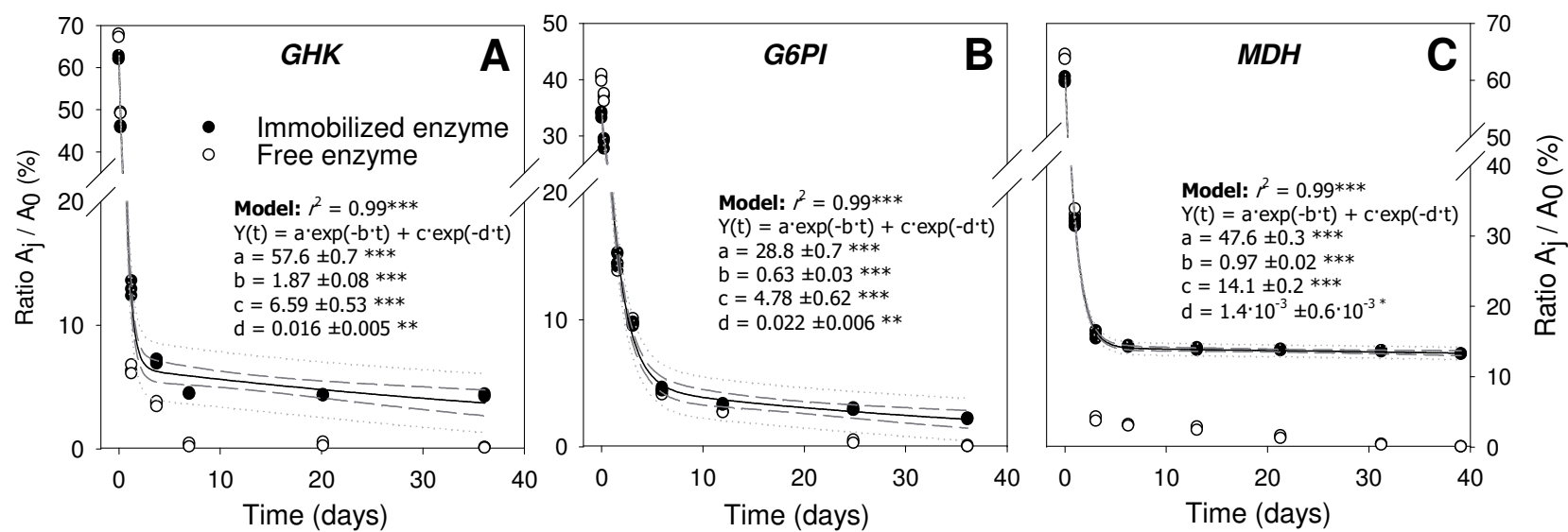

Figure 4: Enzymatic activities in the soil of Theix.